

# TEST REPORT

## CERTIFICATE OF CONFORMITY

**Standard:** EN 55032: 2015+A11:2020, Class A  
EN 61000-3-2: 2014, Class A  
EN IEC 61000-3-2: 2019+A1:2021, Class A  
EN 61000-3-3: 2013+A1:2019+A2:2021  
EN 55035: 2017+A11:2020

**Report No.:** CEBDBO-WTW-P23050006

**Product:** Expandable Fanless Embedded Workstation

**Brand:** Vecow

**Model No.:** ECX-3200

**Series Model:** ECX-3XXXXXXXXXXXXXXXXX ("X" can be 0-9, A-Z or blank for marketing purpose)

**Received Date:** 2023/5/2

**Test Date:** 2023/5/4 ~ 2023/5/11

**Issued Date:** 2023/5/23

**Applicant:** Vecow Co., Ltd.

**Address:** 3F., No.10, Jiankang Rd., Zhonghe Dist., New Taipei City 23586, Taiwan

**Issued By:** Bureau Veritas Consumer Products Services (H.K.) Ltd., Taoyuan Branch  
Lin Kou Laboratories

**Lab Address:** No. 47-2, 14th Ling, Chia Pau Vil., Lin Kou Dist., New Taipei City, Taiwan

**Test Location:** No. 47-2, 14th Ling, Chia Pau Vil., Lin Kou Dist., New Taipei City, Taiwan

**Approved by:** \_\_\_\_\_

Jim Hsiang / Associate Technical Manager

**Date:** \_\_\_\_\_

2023/5/23

This test report consists of 85 pages in total. It may be duplicated completely for legal use with the approval of the applicant. It should not be reproduced except in full, without the written approval of our laboratory. The test results in the report only apply to the tested sample. The test results in this report are traceable to the national or international standards.



Prepared by : Albee Chu / Senior Specialist

## Table of Contents

|   |           |
|---|-----------|
| <b>Release Control Record</b> .....   | <b>4</b>  |
| <b>1 Certificate</b> .....  | <b>5</b>  |
| <b>2 Summary of Test Results</b> .....  | <b>6</b>  |
| 2.1 Performance Criteria .....  | 7         |
| 2.2 Measurement Uncertainty .....   | 10        |
| 2.3 Supplementary Information .....   | 10        |
| <b>3 General Information</b> .....  | <b>11</b> |
| 3.1 Description of EUT .....  | 11        |
| 3.2 Primary Clock Frequencies of Internal Source .....                          | 11        |
| 3.3 Features of EUT .....   | 11        |
| 3.4 Operating Modes of EUT and Determination of Worst Case Operating Mode ..... | 12        |
| 3.5 Test Program Used and Operation Descriptions .....                          | 13        |
| 3.6 Connection Diagram of EUT and Peripheral Devices .....                      | 14        |
| 3.7 Configuration of Peripheral Devices and Cable Connections .....             | 16        |
| <b>4 Test Instruments</b> .....   | <b>19</b> |
| 4.1 Conducted Emissions from Power Ports .....                                  | 19        |
| 4.2 Conducted Emissions from Wired Network Ports .....                          | 20        |
| 4.3 Radiated Emissions up to 1 GHz .....  | 21        |
| 4.4 Radiated Emissions above 1 GHz .....  | 22        |
| 4.5 Harmonic Current Measurement .....  | 23        |
| 4.6 Voltage Fluctuations and Flicker Measurement .....                          | 23        |
| 4.7 Electrostatic Discharges (ESD) .....  | 23        |
| 4.8 Radio Frequency Electromagnetic Field (RS) .....                            | 24        |
| 4.9 Fast Transients Common Mode (EFT) .....                                     | 25        |
| 4.10 Surges .....   | 25        |
| 4.11 Radio Frequency Common Mode (CS) .....                                     | 26        |
| 4.12 Power Frequency Magnetic Field (PFMF) .....                                | 27        |
| 4.13 Voltage Dips and Interruptions (DIP) .....                                 | 27        |
| <b>5 Limits of Test Items</b> .....   | <b>28</b> |
| 5.1 Conducted Emissions from Power Ports .....                                  | 28        |
| 5.2 Conducted Emissions from Wired Network Ports .....                          | 28        |
| 5.3 Radiated Emissions up to 1 GHz .....  | 28        |
| 5.4 Radiated Emissions above 1 GHz .....  | 29        |
| 5.5 Harmonic Current Measurement .....  | 29        |
| 5.6 Voltage Fluctuations and Flicker Measurement .....                          | 30        |
| 5.7 General immunity requirements .....   | 31        |
| <b>6 Test Arrangements</b> .....  | <b>33</b> |
| 6.1 Conducted Emissions from Power Ports .....                                  | 33        |
| 6.2 Conducted Emissions from Wired Network Ports .....                          | 34        |
| 6.3 Radiated Emissions up to 1 GHz .....  | 37        |
| 6.4 Radiated Emissions above 1 GHz .....  | 38        |
| 6.5 Harmonic Current Measurement .....  | 39        |
| 6.6 Voltage Fluctuations and Flicker Measurement .....                          | 39        |
| 6.7 Electrostatic Discharges (ESD) .....  | 40        |
| 6.8 Radio Frequency Electromagnetic Field (RS) .....                            | 42        |
| 6.9 Fast Transients Common Mode (EFT) .....                                     | 43        |
| 6.10 Surges .....   | 44        |
| 6.11 Radio Frequency Common Mode (CS) .....                                     | 46        |
| 6.12 Power Frequency Magnetic Field (PFMF) .....                                | 48        |
| 6.13 Voltage Dips and Interruptions (DIP) .....                                 | 49        |
| <b>7 Test Results of Test Item</b> .....  | <b>50</b> |
| 7.1 Conducted Emissions from Power Ports .....                                  | 50        |
| 7.2 Conducted Emissions from Wired Network Ports .....                          | 54        |



|          |  |           |
|----------|--|-----------|
| 7.3      | Radiated Emissions up to 1 GHz .....                 | 57        |
| 7.4      | Radiated Emissions above 1 GHz.....                  | 59        |
| 7.5      | Harmonic Current Measurement.....                    | 61        |
| 7.6      | Voltage Fluctuations and Flicker Measurement .....   | 62        |
| 7.7      | Electrostatic Discharges (ESD).....                  | 63        |
| 7.8      | Radio Frequency Electromagnetic Field (RS).....      | 66        |
| 7.9      | Fast Transients Common Mode (EFT).....               | 66        |
| 7.10     | Surges .....   | 67        |
| 7.11     | Radio Frequency Common Mode (CS).....                | 68        |
| 7.12     | Power Frequency Magnetic Field (PFMF).....           | 69        |
| 7.13     | Voltage Dips and Interruptions (DIP).....            | 69        |
| <b>8</b> | <b>Pictures of Test Arrangements .....</b>           | <b>70</b> |
| 8.1      | Conducted Emissions from Power Ports.....            | 70        |
| 8.2      | Conducted Emissions from Wired Network Ports .....   | 71        |
| 8.3      | Radiated Emissions up to 1 GHz .....                 | 74        |
| 8.4      | Radiated Emissions above 1 GHz.....                  | 75        |
| 8.5      | Harmonic Current Measurement.....                    | 76        |
| 8.6      | Voltage Fluctuations and Flicker Measurement .....   | 76        |
| 8.7      | Electrostatic Discharges (ESD).....                  | 77        |
| 8.8      | Radio Frequency Electromagnetic Field (RS).....      | 78        |
| 8.9      | Fast Transients Common Mode (EFT).....               | 79        |
| 8.10     | Surges .....   | 81        |
| 8.11     | Radio Frequency Common Mode (CS).....                | 82        |
| 8.12     | Power Frequency Magnetic Field (PFMF).....           | 84        |
| 8.13     | Voltage Dips and Interruptions (DIP).....            | 84        |
| <b>9</b> | <b>Information of the Testing Laboratories .....</b> | <b>85</b> |



## Release Control Record

| Issue No.            | Description       | Date Issued |
|----------------------|-------------------|-------------|
| CEBDBO-WTW-P23050006 | Original release. | 2023/5/23   |

## 1 Certificate

**Product:** Expandable Fanless Embedded Workstation

**Brand:** Vecow

**Test Model:** ECX-3200

**Series Model:** ECX-3XXXXXXXXXXXXXXXXX ("X" can be 0-9, A-Z or blank for marketing purpose)

**Sample Status:** Engineering sample

**Applicant:** Vecow Co., Ltd.

**Test Date:** 2023/5/4 ~ 2023/5/11

**Standard:** EN 55032: 2015+A11:2020, Class A  
EN 61000-3-2: 2014, Class A  
EN IEC 61000-3-2: 2019+A1:2021, Class A  
EN 61000-3-3: 2013+A1:2019+A2:2021  
EN 55035: 2017+A11:2020

**Measurement procedure:** EN 61000-4-2: 2009 / IEC 61000-4-2: 2008 ED. 2.0  
EN IEC 61000-4-3: 2020 / IEC 61000-4-3: 2020 ED. 4.0  
EN 61000-4-4: 2012 / IEC 61000-4-4: 2012 ED. 3.0  
EN 61000-4-5: 2014+A1:2017 / IEC 61000-4-5: 2017 ED. 3.1  
EN 61000-4-6: 2014+AC:2015 / IEC 61000-4-6: 2013 ED. 4.0  
EN 61000-4-8: 2010 / IEC 61000-4-8: 2009 ED. 2.0  
EN IEC 61000-4-11: 2020+AC:2020 / IEC 61000-4-11: 2020 ED. 3.0

The above equipment has been tested by **Bureau Veritas Consumer Products Services (H.K.) Ltd., Taoyuan Branch**, and found compliance with the requirement of the above standards. The test record, data evaluation & Equipment Under Test (EUT) configurations represented herein are true and accurate accounts of the measurements of the sample's EMC characteristics under the conditions specified in this report.

## 2 Summary of Test Results

The test items that the EUT need to perform in accordance with its interfaces, evaluated functions are as follows:

| Standard                         | Test Item                                    | Result | Remark  |
|----------------------------------|--|--------|---|
| EN 55032                         | Conducted Emissions from Power Ports         | Pass   | Minimum passing Class A margin is -22.51 dB at 1.61283 MHz  |
| EN 55032                         | Conducted Emissions from Wired Network Ports | Pass   | Minimum passing Class A margin is -22.13 dB at 17.69417 MHz   |
| EN 55032                         | Radiated Emissions up to 1 GHz               | Pass   | Minimum passing Class A margin is -0.63 dB at 662.49 MHz  |
| EN 55032                         | Radiated Emissions above 1 GHz               | Pass   | Minimum passing Class A margin is -5.51 dB at 1540.01 MHz   |
| EN 61000-3-2<br>EN IEC 61000-3-2 | Harmonic Current Measurement                 | Pass   | Meets Class A Limit   |
| EN 61000-3-3                     | Voltage Fluctuations and Flicker Measurement | Pass   | $P_{st} \leq 1.00$ $d_{max} \leq 4.00\%$<br>$P_{lt} \leq 0.65$ $d_c \leq 3.30\%$<br>$T_{max} \leq 500$ ms   |
| IEC 61000-4-2                    | Electrostatic Discharges (ESD)               | Pass   | For EN 55035<br>Performance Criteria B  |
| IEC 61000-4-3                    | Radio Frequency Electromagnetic Field (RS)   | Pass   | For EN 55035<br>Performance Criteria A  |
| IEC 61000-4-4                    | Fast Transients Common Mode (EFT)            | Pass   | For EN 55035<br>Performance Criteria A  |
| IEC 61000-4-5                    | Surges                                       | Pass   | For EN 55035<br>Performance Criteria A  |
| IEC 61000-4-6                    | Radio Frequency Common Mode (CS)             | Pass   | For EN 55035<br>Performance Criteria A  |
| IEC 61000-4-8                    | Power Frequency Magnetic Field (PFMF)        | Pass   | For EN 55035<br>Performance Criteria A  |
| IEC 61000-4-11                   | Voltage Dips and Interruptions (DIP)         | Pass   | For EN 55035<br><b>For Voltage Dips:</b><br><5% Residual, 0.5 cycle<br>Performance Criteria A<br>70% Residual, 25 cycle<br>Performance Criteria C<br><b>For Voltage Interruptions:</b><br><5% Residual, 250 cycle<br>Performance Criteria C |

Note: Determining compliance based on the results of the compliance measurement, not taking into account measurement instrumentation uncertainty.

## 2.1 Performance Criteria

### For EN 55035

#### General Performance Criteria

These criteria shall be used during the testing of primary functions where no specified in the normative annexes of EN 55035 is applicable.

#### Performance criterion A

The equipment shall continue to operate as intended without operator intervention. No degradation of performance, loss of function or change of operating state is allowed below a performance level specified by the manufacturer when the equipment is used as intended. The performance level may be replaced by a permissible loss of performance. If the minimum performance level or the permissible performance loss is not specified by the manufacturer, then either of these may be derived from the product description and documentation, and by what the user may reasonably expect from the equipment if used as intended.

#### Performance criterion B

During the application of the disturbance, degradation of performance is allowed. However, no unintended change of actual operating state or stored data is allowed to persist after the test.

After the test, the equipment shall continue to operate as intended without operator intervention; no degradation of performance or loss of function is allowed, below a performance level specified by the manufacturer, when the equipment is used as intended. The performance level may be replaced by a permissible loss of performance.

If the minimum performance level (or the permissible performance loss), or recovery time, is not specified by the manufacturer, then either of these may be derived from the product description and documentation, and by what the user may reasonably expect from the equipment if used as intended.

#### Performance criterion C

Loss of function is allowed, provided the function is self-recoverable, or can be restored by the operation of the controls by the user in accordance with the manufacturer's instructions. A reboot or re-start operation is allowed.

Information stored in non-volatile memory, or protected by a battery backup, shall not be lost.

### **Product Specific Performance criteria for network functions**

Equipment that provides these functions transmits and receives data through ports such as an analogue/digital data port. The networking functions are just like network switching and routing ; data transmission ; supervisory...etc.

The particular performance criteria which are specified in the normative annexes of CISPR 35/ EN 55035 take precedence over the corresponding parts of the general performance criteria.

#### **Performance criterion A**

Where relevant, during the application of the test the network function shall, as a minimum, operate ensuring that:

- established connections shall be maintained throughout the application of the test;
- no change of operational state or corruption of stored data occurs;
- no increase in error rate above the figure defined by the manufacturer occurs. The manufacturer should select the most appropriate performance measurement criteria for the product or system, for example bit error rate, block error rate;
- no request for retry above the figure defined by the manufacturer;
- the data transmission rate does not reduce below the figure defined by the manufacturer;
- no protocol failure occurs;
- other verifications are described in F.3.3.1 of CISPR 35/ EN 55035.

#### **Performance criterion B**

Established connections shall be maintained throughout the test, or shall self-recover in a way and timescale that is imperceptible to the user.

The error rate, request for retry and data transmission rates may be degraded during the application of the test. Degradation of the performance as described in criterion A is permitted, provided that the normal operation of the EUT is self-recoverable to the condition established prior to the application of the test.

Where required, as defined in Clause 5 of CISPR 35/ EN 55035, the acceptable operation of the function shall be verified at the completion of the test as described in Table H.1 of CISPR 35/ EN 55035, by confirming the following:

- the EUT's ability to establish a connection,
- the EUT's ability to clear a connection.

During surge testing disconnection is allowed on the analogue/digital data port being tested.

If the EUT is a supervisory equipment, it shall not impact the normal operation of the network being monitored. In addition, any supervisory functions impacted during the period of the test shall return to the state prior to the test. Elements to consider include: alarms, signalling lamps, printer output, network traffic rates, network monitoring.

#### **Performance criterion C**

Degradation of performance as described in criteria A and B is permitted provided that the normal operation of the EUT is self-recoverable to the condition immediately before the application of the test, or can be restored after the test by the operator.



## Product Specific Performance Criteria for xDSL

The particular performance criteria which are specified in the normative annexes of CISPR 35/ EN 55035 take precedence over the corresponding parts of the general performance criteria.

### Performance criterion A

#### Applicable for the test requirement defined in table clause 2.1 of EN 55035

During the swept frequency test the established connection shall be maintained throughout the testing and the information transferred without any additional reproducible errors or loss of synchronisation. If a degradation in performance is observed and the system is adaptive, for example has the capability to automatically retrain in the presence of an interfering signal, then for conducted immunity tests only, the following procedure shall be followed:

- a) For each range of interfering frequencies in which degradation in performance is observed, three frequencies (beginning, middle and end) shall be identified.
- b) At each of the frequencies identified in step a), the interfering signal shall be turned on and the system is allowed to retrain.
- c) If the system is able to retrain and then functions correctly for a dwell time of at least 60 seconds without any additional reproducible errors or loss of synchronisation, then the performance level of the system is considered acceptable.
- d) The frequencies identified in step a) and the data rates achieved in step b) shall be recorded in the test report.

#### Applicable for the test requirement defined in table clause 2.2 of EN 55035

It is important that the modems are able to train in the presence of repetitive impulsive noise and minimize disruption to the end-user where a repetitive impulsive noise source starts after the link has synchronized. Therefore the following procedure and performance criteria shall apply.

The manufacturer shall select the class of impulsive noise protection (INP) to be used for the immunity test and should state this information in the technical documentation and in the test report. The maximum delay shall be set to 8 ms.

**In the absence of impulsive noise:** The modem shall operate without retraining at its target noise margin with a bit rate value depending on the line attenuation and the stationary noise being present on the line. (The actual value will be between the minimum and maximum bit rate values programmed in the port).

The impulsive noise source shall then be applied at the required test level.

**With the impulsive noise applied:** The modem shall operate without retraining and without SES at the bit rate established prior to the application of the impulsive noise. No extra CRC errors shall occur due to the impulsive noise. After the test, the noise margin value shall return to the target noise margin.

### Performance criterion B

#### Applicable for the test requirement defined in table clause 2.3 of EN 55035

Modems shall withstand the occurrence of isolated impulsive noise events. The performance criteria defined in below Table shall be applied.

| Impulse duration (ms) | Performance criteria  |
|-----------------------|---|
| 0.24                  | The application of the impulse shall not cause the xDSL link to lose synchronisation. No CRC errors are permitted.              |
| 10                    | The application of the 5 impulses shall result in less than 75 CRC errors and shall not cause the link to lose synchronisation. |
| 300                   | The application of the impulse shall not cause the xDSL link to lose synchronisation.   |

#### Applicable for the test requirements defined in table clauses 2.5 and 4.5 of EN 55035

For application of this test to the xDSL port, a repetition rate of 100 kHz (burst length 0.75 ms) shall be used.

Degradation of the performance as described in criterion A is permitted in that errors are acceptable during the application of the test. However the application of the test shall not cause the system to lose the established connection or re-train. At the cessation of the test the system shall operate in the condition established prior to the application of the test without user intervention.

After the application of the EFT/B tests to the xDSL or AC mains port, the CRC error count shall not have increased by more than 600 when compared to the count prior to the application of the test.

### Performance criterion C

Degradation of the performance as described in criteria A and B is permitted provided that the normal operation of the EUT is self-recoverable to the condition established prior to application of the test or can be restored after the test by the operator.

## 2.2 Measurement Uncertainty

Where relevant, the following measurement uncertainty levels have been estimated for tests performed on the EUT as specified in CISPR 16-4-2:

| Measurement                                  | Specification    | Expanded Uncertainty<br>(k=2)<br>(±)  | Maximum allowable<br>uncertainty<br>(±)  |
|--|------------------|---|--|
| Conducted Emissions from Power Ports         | 9 kHz ~ 30 MHz   | 3.00 dB   | 3.4 dB ( $U_{\text{CISPR}}$ )  |
| Conducted Emissions from Wired Network Ports | 150 kHz ~ 30 MHz | ISN Cat3 : 3.48 dB<br>ISN Cat5 : 3.94 dB<br>ISN Cat6 : 4.44 dB<br>Current Probe : 1.94 dB<br>Voltage Probe : 3.02 dB<br>Coaxial : 2.48 dB | 5.0 dB ( $U_{\text{CISPR}}$ ) using AAN<br>2.9 dB ( $U_{\text{CISPR}}$ ) using CP<br>3.9 dB ( $U_{\text{CISPR}}$ ) using CVP |
| Radiated Emissions up to 1 GHz               | 30 MHz ~ 1 GHz   | 3m : 5.72 dB<br>10m : 4.38 dB   | 6.3 dB ( $U_{\text{CISPR}}$ )  |
| Radiated Emissions above 1 GHz               | 1 GHz ~ 6 GHz    | 4.42 dB   | 5.2 dB ( $U_{\text{CISPR}}$ )  |

The other instruments specified are routine verified to remain within the calibrated levels, no measurement uncertainty is required to be calculated.

## 2.3 Supplementary Information

There is not any deviation from the test standards for the test method, and no modifications required for compliance.

### 3 General Information

#### 3.1 Description of EUT

|                     |   |
|---------------------|---|
| Product             | Expandable Fanless Embedded Workstation                                     |
| Brand               | Vecow   |
| Test Model          | ECX-3200  |
| Series Model        | ECX-3XXXXXXXXXXXXXXXXX ("X" can be 0-9, A-Z or blank for marketing purpose) |
| Sample Status       | Engineering sample  |
| Operating Software  | WIN10   |
| Power Supply Rating | DC from Adapter   |
| Accessory Device    | Adapter   |
| Data Cable Supplied | N/A   |

Note:

The EUT uses following accessories.

| AC Adapter |             |  |
|------------|-------------|--|
| Brand      | Model       | Specification  |
| LITEON     | PA-1181-28E | AC Input : 100~240V, 2.34A 50-60Hz<br>DC Output : 24V, 7.5A 180W<br>DC Output Cable: 1.5m, with 2 cores. |

#### 3.2 Primary Clock Frequencies of Internal Source

The highest frequency generated or used within the EUT or on which the EUT operates or tunes is 1.9GHz, provided by Vecow Co., Ltd., for detailed internal source, please refer to the manufacturer's specifications.

#### 3.3 Features of EUT

The tests reported herein were performed according to the method specified by Vecow Co., Ltd., for detailed feature description, please refer to the manufacturer's specifications or user's manual.

Please refer to appendix of the report if the applicant has provided additional descriptions of the EUT.

The EUT configured with the following key components:

| Component | Specification                               |
|-----------|---|
| CPU       | Intel® Core™ 12 <sup>th</sup> Gen Processor |
| RAM       | SMART DDR5 4800 8GB non-ECC SODIMM x2       |
| SSD       | Innodisk 2.5" SATA SSD 3ME4 128GB           |

### 3.4 Operating Modes of EUT and Determination of Worst Case Operating Mode

The EUT has been pre-tested under following test modes.

| Test Condition   |  |
|--|--|
| Mode   | Conducted Emissions from Wired Network Ports   |
| 1  | Full system+LAN 3:2.5Gbps with POE CCD + Input Power(230 Vac, 50 Hz)   |
| 2  | Full system+LAN 4:2.5Gbps with POE CCD + Input Power(230 Vac, 50 Hz)   |
| <b>3</b>   | <b>Full system+LAN 5:2.5Gbps with POE CCD + Input Power(230 Vac, 50 Hz)</b>  |
| 4  | Full system+LAN 6:2.5Gbps with POE CCD + Input Power(230 Vac, 50 Hz)   |
| Note: The worst case is that mode 3 is shown in bold.  |  |
| Mode   | Radiated Emissions up to 1 GHz   |
| 1  | Full system,DVI+HDMI:1920*1080,60Hz,Display:3480*2160,60Hz,LAN 1:1Gbps link,LAN 2:1Gbps link,LAN 3~LAN 6 with POE CCD + Input Power(110 Vac, 60 Hz)        |
| <b>2</b>   | <b>Full system,DVI+HDMI:1920*1080,60Hz,Display:3480*2160,60Hz,LAN 1:1Gbps link,LAN 2:1Gbps link,LAN 3~LAN 6 with POE CCD + Input Power(230 Vac, 50 Hz)</b> |
| Notes:   |  |
| 1. There are both standby mode and normal mode to be pre-tested then normal mode has the highest emission value. |  |
| 2. The worst case is that mode 2 is shown in bold.   |  |

Test modes are presented in the report as below.

| Test Condition   |   |
|--|---|
| Mode   | Conducted Emissions from Power Ports  |
| A  | Full system,DVI+HDMI:1920*1080,60Hz,Display:3480*2160,60Hz,LAN 1:1Gbps link,LAN 2:1Gbps link,LAN 3~LAN 6 with POE CCD + Input Power(110 Vac, 60 Hz)                                     |
| B  | Full system,DVI+HDMI:1920*1080,60Hz,Display:3480*2160,60Hz,LAN 1:1Gbps link,LAN 2:1Gbps link,LAN 3~LAN 6 with POE CCD + Input Power(230 Vac, 50 Hz)                                     |
| Mode   | Conducted Emissions from Wired Network Ports  |
| A  | Full system,DVI+HDMI:1920*1080,60Hz,Display:3480*2160,60Hz,LAN 2:1Gbps link,LAN 3~LAN 6 with POE CCD,For LAN 1:1Gbps link test + Input Power(230 Vac, 50 Hz)                            |
| B  | Full system,DVI+HDMI:1920*1080,60Hz,Display:3480*2160,60Hz,LAN 1:1Gbps link,LAN 3~LAN 6 with POE CCD,For LAN 2:1Gbps link test + Input Power(230 Vac, 50 Hz)                            |
| C  | Full system,DVI+HDMI:1920*1080,60Hz,Display:3480*2160,60Hz,LAN 1:1Gbps link,LAN 2:1Gbps link,LAN 3~LAN 6 with POE CCD,For LAN 5:2.5Gbps with POE CCD test + Input Power(230 Vac, 50 Hz) |
| Note: The idle mode of conducted emission test at wired network ports test was pre-tested based on the worst case of link mode. Due to emissions of idle mode being very low compared to link mode, only the link mode data were presented in the test report. |   |
| Mode   | Radiated Emissions up to 1 GHz  |
| A  | Full system,DVI+HDMI:1920*1080,60Hz,Display:3480*2160,60Hz,LAN 1:1Gbps link,LAN 2:1Gbps link,LAN 3~LAN 6 with POE CCD + Input Power(230 Vac, 50 Hz)                                     |
| Mode   | Radiated Emissions above 1 GHz  |
| A  | Full system,DVI+HDMI:1920*1080,60Hz,Display:3480*2160,60Hz,LAN 1:1Gbps link,LAN 2:1Gbps link,LAN 3~LAN 6 with POE CCD + Input Power(230 Vac, 50 Hz)                                     |
| Mode   | Harmonic Current Measurement  |
| A  | Full system,DVI+HDMI:1920*1080,60Hz,Display:3480*2160,60Hz,LAN 1:1Gbps link,LAN 2:1Gbps link,LAN 3~LAN 6 with POE CCD + Input Power(230 Vac, 50 Hz)                                     |
| Mode   | Voltage Fluctuations and Flicker Measurement  |
| A  | Full system,DVI+HDMI:1920*1080,60Hz,Display:3480*2160,60Hz,LAN 1:1Gbps link,LAN 2:1Gbps link,LAN 3~LAN 6 with POE CCD + Input Power(230 Vac, 50 Hz)                                     |

|      |   |
|------|---|
| Mode | Electrostatic Discharges (ESD)  |
| A    | Full system,DVI+HDMI:1920*1080,60Hz,Display:3480*2160,60Hz,LAN 1:1Gbps link,LAN 2:1Gbps link,LAN 3~LAN 6 with POE CCD + Input Power(230 Vac, 50 Hz) |
| Mode | Radio Frequency Electromagnetic Field (RS)  |
| A    | Full system,DVI+HDMI:1920*1080,60Hz,Display:3480*2160,60Hz,LAN 1:1Gbps link,LAN 2:1Gbps link,LAN 3~LAN 6 with POE CCD + Input Power(230 Vac, 50 Hz) |
| Mode | Fast Transients Common Mode (EFT)   |
| A    | Full system,DVI+HDMI:1920*1080,60Hz,Display:3480*2160,60Hz,LAN 1:1Gbps link,LAN 2:1Gbps link,LAN 3~LAN 6 with POE CCD + Input Power(230 Vac, 50 Hz) |
| Mode | Surges  |
| A    | Full system,DVI+HDMI:1920*1080,60Hz,Display:3480*2160,60Hz,LAN 1:1Gbps link,LAN 2:1Gbps link,LAN 3~LAN 6 with POE CCD + Input Power(230 Vac, 50 Hz) |
| Mode | Radio Frequency Common Mode (CS)  |
| A    | Full system,DVI+HDMI:1920*1080,60Hz,Display:3480*2160,60Hz,LAN 1:1Gbps link,LAN 2:1Gbps link,LAN 3~LAN 6 with POE CCD + Input Power(230 Vac, 50 Hz) |
| Mode | Power Frequency Magnetic Field (PFMF)   |
| A    | Full system,DVI+HDMI:1920*1080,60Hz,Display:3480*2160,60Hz,LAN 1:1Gbps link,LAN 2:1Gbps link,LAN 3~LAN 6 with POE CCD + Input Power(230 Vac, 50 Hz) |
| Mode | Voltage Dips and Interruptions (DIP)  |
| A    | Full system,DVI+HDMI:1920*1080,60Hz,Display:3480*2160,60Hz,LAN 1:1Gbps link,LAN 2:1Gbps link,LAN 3~LAN 6 with POE CCD + Input Power(230 Vac, 50 Hz) |

### 3.5 Test Program Used and Operation Descriptions

#### For Emission tests (Harmonics & Flicker excluded)

- Turned on the power of all equipment.
- EUT ran a test program (BurnIntest) to enable all functions.
- EUT read and wrote messages to/ from internal storage drives, and external storage drives.
- EUT sent "ITU-R 471-1" messages to monitor. Then the displayed messages on their screens simultaneously.
- EUT sent and received messages to/ from Laptop (kept in a remote area) via STP cable.
- EUT received message from POE camera via STP cable.
- EUT sent "1kHz audio" signal to earphone.
- Steps c-g were repeated.

#### For Harmonics, Flicker & Immunity tests

- Turned on the power of all equipment.
- EUT ran a test program (BurnIntest) to enable all functions.
- EUT read and wrote messages to/ from internal storage drives, and external storage drives.
- EUT sent "color bars with moving element" messages to monitor. Then the displayed messages on their screens simultaneously.
- EUT sent and received messages to/ from Laptop (kept in a remote area) via STP cable.
- EUT received message from POE camera via STP cable.
- EUT sent "1kHz audio" signal to Headset.
- Steps c-g were repeated.

### 3.6 Connection Diagram of EUT and Peripheral Devices

For Emission tests (Harmonics & Flicker excluded):

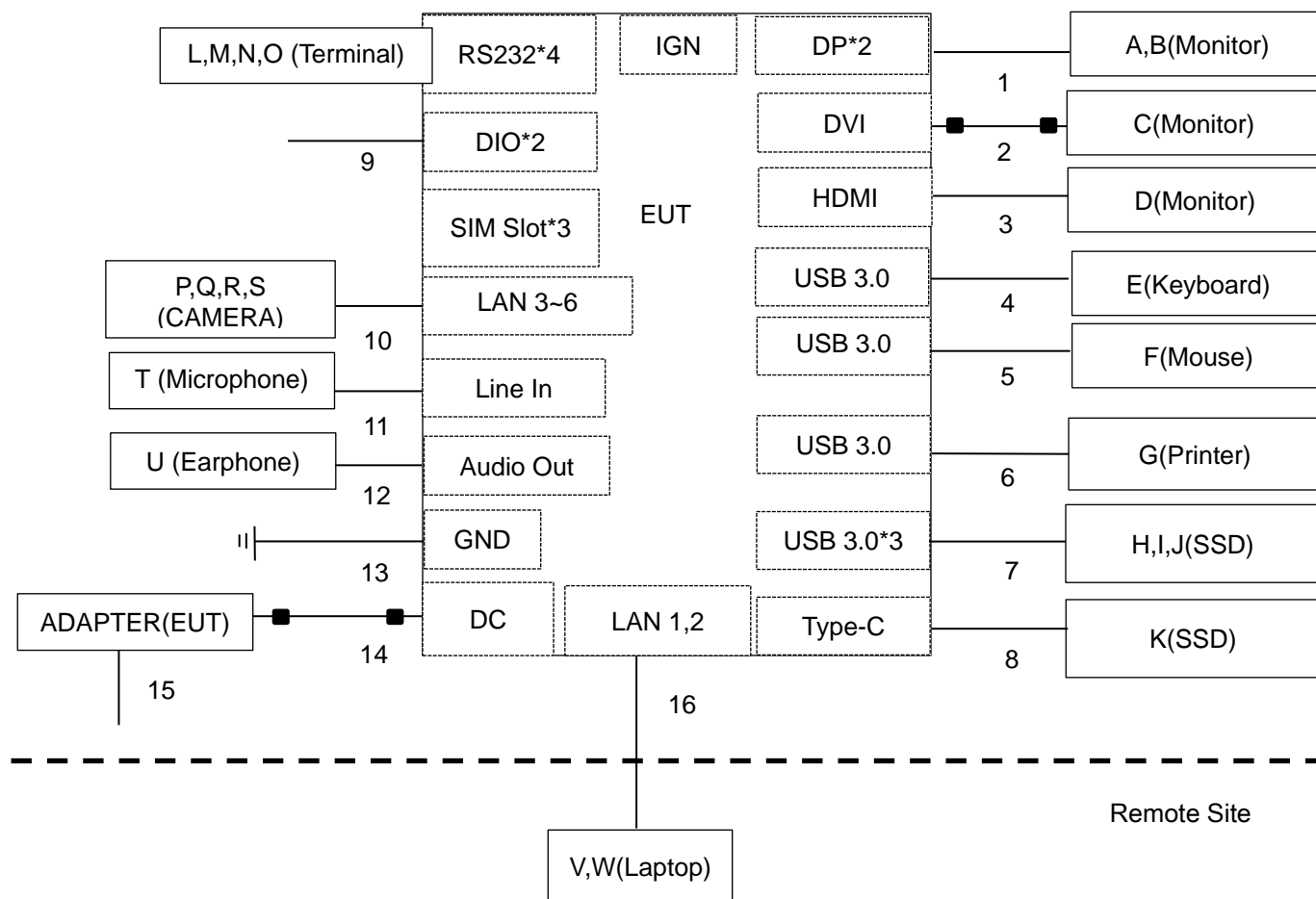

For Harmonics, Flicker & Immunity tests

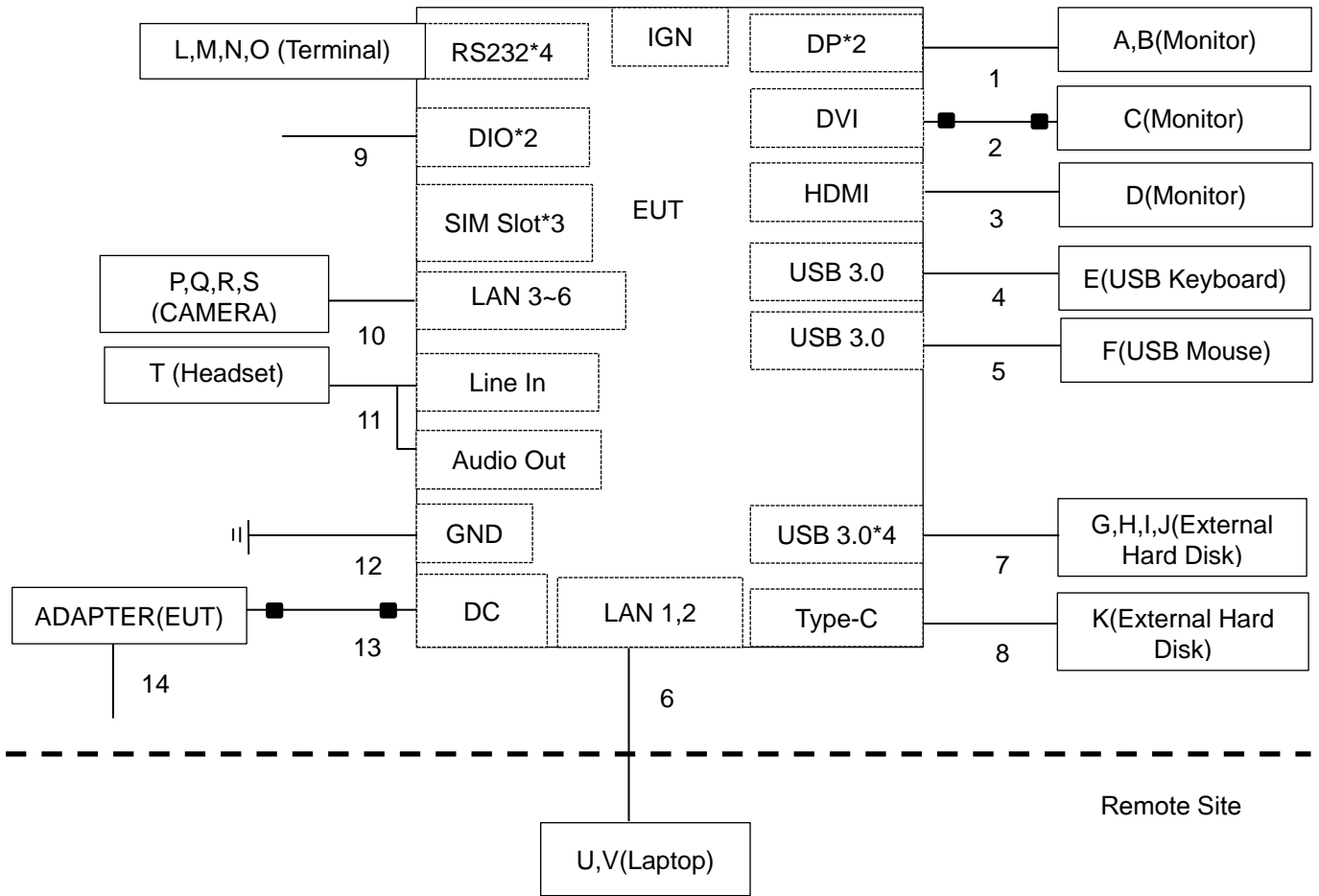

### 3.7 Configuration of Peripheral Devices and Cable Connections

#### For Emission tests (Harmonics & Flicker excluded)

| ID | Product      | Brand   | Model No.              | Serial No.               | FCC ID       | Remarks               |
|----|--------------|---------|------------------------|--------------------------|--------------|-----------------------|
| A  | Monitor      | ASUS    | PA279CV                | M7LMTF235958             | DoC          | Provided by Lab       |
| B  | Monitor      | ASUS    | PA279CV                | M7LMTF236012             | DoC          | Provided by Lab       |
| C  | Monitor      | DELL    | U2410                  | CN082WXD728720CC0KCL     | DoC          | Provided by Lab       |
| D  | Monitor      | DELL    | U2410                  | CN082WXD728720CC10NL     | DoC          | Provided by Lab       |
| E  | USB Keyboard | Dell    | KB216t                 | CN-0W33XP-LO300-7CL-191E | N/A          | Provided by Lab       |
| F  | USB Mouse    | DELL    | MOCZUL                 | CN-049TWY-PRC00-77B-007R | N/A          | Provided by Lab       |
| G  | Printer      | HP      | HP Officejet Pro 251dW | N/A                      | B94SDGOB1191 | Provided by Lab       |
| H  | USB 3.1 SSD  | Crucial | CT500X8SSD9            | 1941E323D093             | N/A          | Provided by Lab       |
| I  | USB 3.1 SSD  | Crucial | CT500X8SSD9            | 1941E323D095             | N/A          | Provided by Lab       |
| J  | USB 3.1 SSD  | Crucial | CT500X8SSD9            | 1941E3201117             | N/A          | Provided by Lab       |
| K  | USB 3.1 SSD  | Crucial | CT500X8SSD9            | 1941E320114D             | N/A          | Provided by Lab       |
| L  | Terminal     | N/A     | N/A                    | N/A                      | N/A          | Supplied by applicant |
| M  | Terminal     | N/A     | N/A                    | N/A                      | N/A          | Supplied by applicant |
| N  | Terminal     | N/A     | N/A                    | N/A                      | N/A          | Supplied by applicant |
| O  | Terminal     | N/A     | N/A                    | N/A                      | N/A          | Supplied by applicant |
| P  | CAMARA       | 3MP     | A301RZ-0309P           | T42211285                | N/A          | Supplied by applicant |
| Q  | CAMARA       | 3MP     | A301RZ-0309P           | T42211278                | N/A          | Supplied by applicant |
| R  | CAMARA       | 3MP     | A301RZ-0309P           | T42211283                | N/A          | Supplied by applicant |
| S  | CAMARA       | 3MP     | A301RZ-0309P           | T42211277                | N/A          | Supplied by applicant |
| T  | Microphone   | E-books | E-EPB099               | N/A                      | N/A          | Provided by Lab       |
| U  | Earphonne    | PHILIPS | SBC HL145              | N/A                      | N/A          | Provided by Lab       |
| V  | Laptop       | LENOVO  | T480                   | PF1EK03U                 | N/A          | Provided by Lab       |
| W  | Laptop       | LENOVO  | T480                   | PF1EZSAW                 | N/A          | Provided by Lab       |



| ID | Cable Descriptions    | Qty. | Length (m) | Shielding (Yes/No) | Cores (Qty.) | Remarks  |
|----|-----------------------|------|------------|--------------------|--------------|--|
| 1  | DP cable              | 2    | 1.8        | Yes                | 0            | Provided by Lab  |
| 2  | DVI cable             | 1    | 1.8        | Yes                | 2            | Provided by Lab  |
| 3  | HDMI cable            | 1    | 2          | Yes                | 0            | Provided by Lab,<br>HDMI 2.0<br>(Brand: Amber,<br>Model: HDMI-AA120) |
| 4  | USB cable             | 1    | 1.8        | Yes                | 0            | Provided by Lab  |
| 5  | USB cable             | 1    | 1.8        | Yes                | 0            | Provided by Lab  |
| 6  | USB cable             | 1    | 1.8        | Yes                | 0            | Provided by Lab  |
| 7  | USB Type A to C cable | 3    | 1          | Yes                | 0            | Provided by Lab  |
| 8  | Type C to C cable     | 1    | 1          | Yes                | 0            | Provided by Lab  |
| 9  | Data cable            | 5    | 0.3        | No                 | 0            | Supplied by applicant  |
| 10 | RJ45 (Cat. 5e) cable  | 4    | 1.5        | Yes                | 0            | Provided by Lab  |
| 11 | Audio (3.5") cable    | 1    | 2          | No                 | 0            | Provided by Lab  |
| 12 | Audio (3.5") cable    | 1    | 1.2        | No                 | 0            | Provided by Lab  |
| 13 | GND (PE) cable        | 1    | 1.8        | No                 | 0            | Provided by Lab  |
| 14 | DC power cable        | 1    | 1.5        | No                 | 2            | Accessory of EUT   |
| 15 | AC power(3pin) cable  | 1    | 1.8        | No                 | 0            | Provided by Lab  |
| 16 | RJ45 (Cat. 5e) cable  | 2    | 10         | Yes                | 0            | Provided by Lab  |

**For Harmonics, Flicker & Immunity tests**

| ID | Product            | Brand   | Model No.     | Serial No.               | FCC ID | Remarks               |
|----|--------------------|---------|---------------|--------------------------|--------|-----------------------|
| A  | Monitor            | DELL    | P2415Qb       | CN-OGTTPW-74261-662-OAGL | N/A    | Provided by Lab       |
| B  | Monitor            | ASUS    | MG28UQ        | H8LMTF147971             | N/A    | Provided by Lab       |
| C  | Monitor            | DELL    | U2413f        | CN-06VNX5-72872-42B-A4EL | DoC    | Provided by Lab       |
| D  | Monitor            | ASUS    | MG28UQ        | HCLMTF053703             | N/A    | Provided by Lab       |
| E  | USB Keyboard       | HP      | SK-2085       | N/A                      | N/A    | Provided by Lab       |
| F  | USB Mouse          | DELL    | MS116p        | CN-0145WW-PRC00-01D-054P | DoC    | Provided by Lab       |
| G  | External Hard Disk | WD      | WDBATL5000ABK | 2121FZ400129             | N/A    | Provided by Lab       |
| H  | External Hard Disk | WD      | WDBATL5000ABK | 2121FZ400551             | N/A    | Provided by Lab       |
| I  | External Hard Disk | WD      | WDBATL5000ABK | 2121FZ400465             | N/A    | Provided by Lab       |
| J  | External Hard Disk | WD      | WDBATL5000ABK | 2121FZ400062             | N/A    | Provided by Lab       |
| K  | External Hard Disk | WD      | WDBATL5000ABK | 2121FZ400674             | N/A    | Provided by Lab       |
| L  | Terminal           | N/A     | N/A           | N/A                      | N/A    | Supplied by applicant |
| M  | Terminal           | N/A     | N/A           | N/A                      | N/A    | Supplied by applicant |
| N  | Terminal           | N/A     | N/A           | N/A                      | N/A    | Supplied by applicant |
| O  | Terminal           | N/A     | N/A           | N/A                      | N/A    | Supplied by applicant |
| P  | CAMARA             | 3MP     | A301RZ-0309P  | T42211285                | N/A    | Supplied by applicant |
| Q  | CAMARA             | 3MP     | A301RZ-0309P  | T42211278                | N/A    | Supplied by applicant |
| R  | CAMARA             | 3MP     | A301RZ-0309P  | T42211283                | N/A    | Supplied by applicant |
| S  | CAMARA             | 3MP     | A301RZ-0309P  | T42211277                | N/A    | Supplied by applicant |
| T  | Headset            | E-books | E-EPB099      | N/A                      | N/A    | Provided by Lab       |
| U  | Laptop             | Dell    | E5420         | FHNT4S1                  | N/A    | Provided by Lab       |
| V  | Laptop             | Dell    | E5430         | DJ9CVY1                  | N/A    | Provided by Lab       |

| ID | Cable Descriptions    | Qty. | Length (m) | Shielding (Yes/No) | Cores (Qty.) | Remarks   |
|----|-----------------------|------|------------|--------------------|--------------|---|
| 1  | DP cable              | 2    | 1.8        | Yes                | 0            | Provided by Lab   |
| 2  | DVI cable             | 1    | 1.8        | Yes                | 2            | Provided by Lab   |
| 3  | HDMI cable            | 1    | 2          | Yes                | 0            | Provided by Lab, HDMI 2.0 (Brand: Amber, Model: HDMI-AA120) |
| 4  | USB 2.0 cable         | 1    | 1.8        | Yes                | 0            | Provided by Lab   |
| 5  | USB 2.0 cable         | 1    | 1.8        | Yes                | 0            | Provided by Lab   |
| 6  | RJ45 (Cat. 5e) cable  | 2    | 10         | Yes                | 0            | Provided by Lab   |
| 7  | USB Type A to C cable | 4    | 0.5        | Yes                | 0            | Provided by Lab   |
| 8  | Type C to C cable     | 1    | 0.5        | Yes                | 0            | Provided by Lab   |
| 9  | Data cable            | 5    | 0.3        | No                 | 0            | Supplied by applicant                                       |
| 10 | RJ45 (Cat. 5e) cable  | 4    | 5          | Yes                | 0            | Provided by Lab   |
| 11 | Audio (3.5") cable    | 1    | 2          | No                 | 0            | Provided by Lab   |
| 12 | GND (PE) cable        | 1    | 3          | No                 | 0            | Provided by Lab   |
| 13 | DC power cable        | 1    | 1.5        | No                 | 2            | Accessory of EUT  |
| 14 | AC power(3pin) cable  | 1    | 1.8        | No                 | 0            | Provided by Lab   |

## 4 Test Instruments

The calibration interval of the all test instruments are 12 months and the calibrations are traceable to NML/ROC and NIST/USA.

### 4.1 Conducted Emissions from Power Ports

| Description<br>Manufacturer               | Model No.     | Serial No.   | Calibrated<br>Date | Calibrated<br>Until |
|---|---------------|--------------|--------------------|---------------------|
| 50 ohm terminal<br>LYNICS                 | 0900510       | E1-011285    | 2022/9/19          | 2023/9/18           |
|   |               | E1-011286    | 2022/9/19          | 2023/9/18           |
| 50 Ohms Terminator<br>LYNICS              | 0900510       | E1-01-305    | 2023/2/13          | 2024/2/12           |
| Attenuator<br>STI                         | STI02-2200-10 | NO.3         | 2022/10/21         | 2023/10/20          |
| Coupling/Dcoupling Network<br>Schwarzbeck | CDNE-M2       | 00097        | 2022/6/1           | 2023/5/31           |
|   | CDNE-M3       | 00091        | 2022/6/1           | 2023/5/31           |
| Coupling/Dcoupling Network<br>TESEQ       | CDN A201A     | 44601        | 2022/12/14         | 2023/12/13          |
| DC LISN<br>R&S                            | ESH3-Z6       | 100219       | 2022/8/2           | 2023/8/1            |
|   |               | 844950/018   | 2022/8/2           | 2023/8/1            |
| DC LISN<br>Schwarzbeck                    | NNLK 8121     | 8121-808     | 2023/5/2           | 2024/5/1            |
| High Voltage Probe<br>Schwarzbeck         | TK9420        | 00982        | 2022/12/14         | 2023/12/13          |
| Isolation Transformer<br>Erika Fiedler    | D-65396       | 017          | 2022/9/8           | 2023/9/7            |
| LISN<br>EMCO                              | 3825/2        | 9204-1964    | 2022/6/17          | 2023/6/16           |
|   |               | 9504-2359    | 2022/8/2           | 2023/8/1            |
| LISN<br>R&S                               | ENV216        | 101195       | 2022/8/1           | 2023/7/31           |
|   |               | 101196       | 2022/5/24          | 2023/5/23           |
|   |               | 101197       | 2022/7/5           | 2023/7/4            |
| LISN<br>Schwarzbeck                       | NNLK 8121     | 8121-00759   | 2022/8/18          | 2023/8/17           |
|   |               | 8121-731     | 2022/5/26          | 2023/5/25           |
|   | NNLK8129      | 8129229      | 2022/6/8           | 2023/6/7            |
| RF Coaxial Cable<br>Commate               | 5D-FB         | Cable-CO3-01 | 2022/9/14          | 2023/9/13           |
| Software<br>BVADT                         | Cond_V7.3.7.4 | N/A          | N/A                | N/A                 |
| Test Receiver<br>R&S                      | ESR3          | 102413       | 2023/2/7           | 2024/2/6            |

Notes:

1. The test was performed in Linkou Conduction 3.
2. The VCCI Site Registration No. C-10274.
3. Tested Date: 2023/5/5

#### 4.2 Conducted Emissions from Wired Network Ports

| Description<br>Manufacturer               | Model No.          | Serial No.   | Calibrated<br>Date | Calibrated<br>Until |
|---|--------------------|--------------|--------------------|---------------------|
| 50 ohm terminal<br>LYNICS                 | 0900510            | E1-011285    | 2022/9/19          | 2023/9/18           |
|   |                    | E1-011286    | 2022/9/19          | 2023/9/18           |
| Coupling/Dcoupling Network<br>Schwarzbeck | CDNE-M2            | 00097        | 2022/6/1           | 2023/5/31           |
|   | CDNE-M3            | 00091        | 2022/6/1           | 2023/5/31           |
| Coupling/Dcoupling Network<br>TESEQ       | CDN A201A          | 44601        | 2022/12/14         | 2023/12/13          |
| DC LISN<br>Schwarzbeck                    | NNLK 8121          | 8121-808     | 2023/5/2           | 2024/5/1            |
| Impedance-stabilization-network<br>TESEQ  | ISN T8-Cat.6       | 53159        | 2023/3/22          | 2024/3/21           |
|   | ISN T400A          | 28573        | 2022/8/17          | 2023/8/16           |
|   | ISN T800           | 36181        | 2022/8/19          | 2023/8/18           |
| ISN<br>FCC                                | F-071115-1057-1    | 20650        | 2022/6/15          | 2023/6/14           |
|   |                    | 20651        | 2023/3/15          | 2024/3/14           |
|   |                    | 20652        | 2023/1/10          | 2024/1/9            |
|   | F-071115-1057-1-09 | 120033       | 2022/6/16          | 2023/6/15           |
| ISN<br>TESEQ                              | ISN S751           | 40599        | 2022/8/18          | 2023/8/17           |
|   | ISN ST08           | 41212        | 2022/8/16          | 2023/8/15           |
| Isolation Transformer<br>Erika Fiedler    | D-65396            | 017          | 2022/9/8           | 2023/9/7            |
| LISN<br>EMCO                              | 3825/2             | 9204-1964    | 2022/6/17          | 2023/6/16           |
|   |                    | 9504-2359    | 2022/8/2           | 2023/8/1            |
| LISN<br>R&S                               | ENV216             | 101195       | 2022/8/1           | 2023/7/31           |
|   |                    | 101196       | 2022/5/24          | 2023/5/23           |
|   |                    | 101197       | 2022/7/5           | 2023/7/4            |
| LISN<br>Schwarzbeck                       | NNLK 8121          | 8121-731     | 2022/5/26          | 2023/5/25           |
|   |                    | 8121-00759   | 2022/8/18          | 2023/8/17           |
|   | NNLK8129           | 8129229      | 2022/6/8           | 2023/6/7            |
| RF Coaxial Cable<br>Commate               | 5D-FB              | Cable-CO3-01 | 2022/9/14          | 2023/9/13           |
| RF Current Probe<br>FCC                   | F-33-4             | 56           | 2022/8/1           | 2023/7/31           |
| Software<br>BVADT                         | ISN_V7.3.7.4       | N/A          | N/A                | N/A                 |
| Test Receiver<br>R&S                      | ESR3               | 102413       | 2023/2/7           | 2024/2/6            |

Notes:

1. The test was performed in Linkou Conduction 3 (ISN 3).
2. The VCCI Site Registration No. T-11651.
3. Tested Date: 2023/5/5

### 4.3 Radiated Emissions up to 1 GHz

| Description<br>Manufacturer               | Model No.            | Serial No.   | Calibrated<br>Date | Calibrated<br>Until |
|---|----------------------|--------------|--------------------|---------------------|
| ADT. Tower                                | AT100                | 0205         | N/A                | N/A                 |
| ADT. Turn Table                           | TT100                | 0205         | N/A                | N/A                 |
| Attenuator<br>Mini-Circuits               | UNAT-5+              | PAD-ST2-01   | 2022/10/21         | 2023/10/20          |
| Bi-log Broadband Antenna<br>Schwarzbeck   | VULB9168             | 9168-303     | 2022/10/25         | 2023/10/24          |
| Coupling/Dcoupling Network<br>Schwarzbeck | CDNE-M2              | 00097        | 2022/6/1           | 2023/5/31           |
|   | CDNE-M3              | 00091        | 2022/6/1           | 2023/5/31           |
| Preamplifier<br>Agilent                   | 8447D                | 2944A11062   | 2023/2/15          | 2024/2/14           |
| Pre_Amplifier<br>EMCI                     | EMC9135              | 980711       | 2023/3/12          | 2024/3/11           |
| Pre_Amplifier<br>HP                       | 8447D                | 2944A08313   | 2023/2/15          | 2024/2/14           |
| RF Coaxial Cable<br>Pacific               | 8D-FB                | Cable-ST2-01 | 2022/10/21         | 2023/10/20          |
| Software<br>BVADT                         | Radiated_V7.6.15.9.5 | N/A          | N/A                | N/A                 |
| TEST RECEIVER<br>R&S                      | ESCS 30              | 100276       | 2023/4/20          | 2024/4/19           |
|   |                      | 100292       | 2022/8/30          | 2023/8/29           |

Notes:

1. The test was performed in Linkou Open Site2 , The test site validated date: 2022/7/16 (NSA)
2. The VCCI Site Registration No. R-10237.
3. Tested Date: 2023/5/4

#### 4.4 Radiated Emissions above 1 GHz

| Description<br>Manufacturer                | Model No.        | Serial No.        | Calibrated<br>Date | Calibrated<br>Until |
|--|------------------|-------------------|--------------------|---------------------|
| Attenuator<br>Mini-Circuits                | BW-K3-2W44+      | PAD-CH7-03        | 2022/7/7           | 2023/7/6            |
|  | BW-N4W5+         | PAD-CH10-02       | 2022/7/7           | 2023/7/6            |
| Band Pass Filter<br>MICRO-TRONICS          | BRM17690         | 005               | 2022/5/26          | 2023/5/25           |
| Fix tool for Boresight antenna tower<br>BV | BAF-01           | 9                 | N/A                | N/A                 |
| Horn Antenna<br>EMCO                       | 3115             | 6714              | 2022/11/13         | 2023/11/12          |
| Horn Antenna<br>ETS-Lindgren               | 3117-PA          | 00215857          | 2023/2/3           | 2024/2/2            |
| Horn Antenna<br>Schwarzbeck                | BBHA 9170        | 212               | 2022/10/20         | 2023/10/19          |
| Notch Filter<br>MICRO-TRONICS              | BRC50703-01      | 010               | 2022/5/26          | 2023/5/25           |
| Pre-amplifier<br>HP                        | 8449B            | 3008A01292        | 2023/2/16          | 2024/2/15           |
| Pre_Amplifier<br>EMCI                      | EMC0126545       | 980076            | 2023/2/16          | 2024/2/15           |
|  | EMC184045B       | 980235            | 2023/2/16          | 2024/2/15           |
| RF Coaxial Cable<br>EM                     | EM102-KMKM-3.5   | EM102-KMKM-3.5-02 | 2022/9/27          | 2023/9/26           |
| RF Coaxial Cable<br>WOKEN                  | WC01             | Cable-CH10-03     | 2022/9/27          | 2023/9/26           |
| Software<br>BVADT                          | Radiated_V8.7.08 | N/A               | N/A                | N/A                 |
| Spectrum<br>Keysight                       | N9020B           | MY60110438        | 2022/12/6          | 2023/12/5           |
|  |                  | MY60112260        | 2022/5/21          | 2023/5/20           |
| Test Receiver<br>Agilent                   | N9038A           | MY51210137        | 2022/6/9           | 2023/6/8            |
| Turn Table & Tower<br>Max Full             | MF7802           | MF780208216       | N/A                | N/A                 |

Notes:

1. The test was performed in Linkou 966 Chamber 3 (CH 10).
2. The VCCI Site Registration No. G-10427.
3. Tested Date: 2023/5/6

#### 4.5 Harmonic Current Measurement

| Description<br>Manufacturer             | Model No.     | Serial No.            | Calibrated<br>Date | Calibrated<br>Until |
|---|---------------|-----------------------|--------------------|---------------------|
| Harmonics and Flicker Analyzer<br>TESEQ | PROFLINE 2105 | 1632A00983&1639A01863 | 2022/6/8           | 2023/6/7            |
| Software                                | CTS 4         | N/A                   | N/A                | N/A                 |

Notes:

1. The test was performed in Linkou EMS Room No.1.
2. Tested Date: 2023/5/9

#### 4.6 Voltage Fluctuations and Flicker Measurement

Refer to section 4.5 to get information of the instruments.

#### 4.7 Electrostatic Discharges (ESD)

| Description<br>Manufacturer                | Model No.                             | Serial No.              | Calibrated<br>Date | Calibrated<br>Until |
|--|---------------------------------------|-------------------------|--------------------|---------------------|
| Electronic Discharge Simulator<br>Noiseken | ESS-2000                              | ESS0382041              | 2022/10/7          | 2023/10/6           |
| Electrostatic Analog Tester<br>TESEQ       | NSG 438                               | 1875                    | 2022/11/11         | 2023/11/10          |
| ESD Generator<br>EM Test                   | Dito//DM-150/330//DM-<br>150/330-rfci | P1315117252/P1317117852 | 2022/7/7           | 2023/7/6            |
| ESD Simulator<br>EM TEST                   | Dito                                  | V0707102251             | 2023/3/24          | 2024/3/23           |
| ESD Simulator<br>KeyTek                    | MZ15/EC                               | 0504259                 | 2022/11/8          | 2023/11/7           |
| ESD Simulator<br>TESEQ                     | NSG 438                               | 1364                    | 2022/12/2          | 2023/12/1           |

Notes:

1. The test was performed in Linkou ESD Room No.01.
2. Tested Date: 2023/5/10

#### 4.8 Radio Frequency Electromagnetic Field (RS)

| Description<br>Manufacturer                             | Model No.             | Serial No. | Calibrated<br>Date | Calibrated<br>Until |
|---|-----------------------|------------|--------------------|---------------------|
| * Broadband Field Meter<br>Narda                        | NBM-550               | B-0872     | 2022/3/18          | 2024/3/17           |
| Amplifier<br>BONN                                       | BSA 0125-800          | 1912556    | N/A                | N/A                 |
| Amplifier<br>TESTQ                                      | CBA 1G-275            | T44344     | N/A                | N/A                 |
| Audio analyzer<br>R&S                                   | UPV                   | 104565     | 2022/5/10          | 2023/5/9            |
| Band pass filter<br>B&K                                 | WH3278                | N/A        | 2022/6/5           | 2023/6/4            |
| BiconiLog Antenna<br>EMCO                               | 3141                  | 1001       | N/A                | N/A                 |
| CHANCE MOST<br>Full Anechoic<br>Chamber (9x5x3m)        | Chance Most           | RS-002     | 2023/2/3           | 2024/2/2            |
| Controller<br>AR  | SC1000M3              | 305910     | N/A                | N/A                 |
| Ear Simulator Telephonometry<br>B&K                     | 4185                  | 2553594    | N/A                | N/A                 |
| High Gain Horn Antenna<br>AR                            | AT4010                | 0329800    | N/A                | N/A                 |
| LOG ANTENNA<br>Schwarzbeck                              | Schwarzbeck Stlp 9149 | 9149-260   | N/A                | N/A                 |
| Log-Periodic Antenna<br>AR                              | AT6080                | 0329465    | N/A                | N/A                 |
| Power Amplifier<br>AR                                   | 35S4G8AM4             | 0326094    | N/A                | N/A                 |
|   | 100S1G4M3             | 0329249    | N/A                | N/A                 |
| Power Meter<br>BOONTON                                  | 4232A                 | 94901      | 2022/6/6           | 2023/6/5            |
| Power Sensor<br>BOONTON                                 | 51011-EMC             | 32807      | 2022/6/6           | 2023/6/5            |
|   |                       | 32832      | 2022/6/6           | 2023/6/5            |
| Pressure-field Microphone<br>B&K                        | 4192                  | 3190854    | 2022/12/12         | 2023/12/11          |
| Signal Generator<br>Agilent                             | E8257D                | MY48050465 | 2022/6/29          | 2023/6/28           |
| Software<br>BVADT                                       | RS_V7.6               | N/A        | N/A                | N/A                 |
| Software  | ABMS_ V7.4.3          | N/A        | N/A                | N/A                 |
| Two channel microphone<br>conditioning amplifier<br>B&K | 2690 A OS2            | 2645274    | 2022/6/5           | 2023/6/4            |
| Wireless Connection Tester<br>R&S                       | CMW270                | 101075     | 2023/4/28          | 2024/4/27           |

#### Notes:

- \* The calibration interval of the above test instruments is 24 months and the calibrations are traceable to NML/ROC and NIST/USA
- The test was performed in Linkou RS Room No.02.
- Tested Date: 2023/5/9



#### 4.9 Fast Transients Common Mode (EFT)

| Description<br>Manufacturer | Model No. | Serial No. | Calibrated<br>Date | Calibrated<br>Until |
|-----------------------------|-----------|------------|--------------------|---------------------|
| Burst generator<br>Haefely  | PEFT 4010 | 154954     | 2023/3/24          | 2024/3/23           |

Notes:

1. The test was performed in Linkou EFT Room.
2. Tested Date: 2023/5/9

#### 4.10 Surges

| Description<br>Manufacturer                                      | Model No.  | Serial No. | Calibrated<br>Date | Calibrated<br>Until |
|--|------------|------------|--------------------|---------------------|
| CDN for Unshielded Unsymmetrical<br>Signal & Data Lines<br>TESEQ | CDN117     | 40144      | 2022/8/23          | 2023/8/22           |
| Coupling Decoupling Network<br>EMC-Partner                       | CDN-UTP8   | 045        | 2022/8/2           | 2023/8/1            |
| Coupling Decoupling Network<br>TESEQ                             | CDN HSS-2  | 41009      | 2023/4/18          | 2024/4/17           |
| Surge Coupling Decoupling<br>Network<br>TESEQ                    | CDN 118-T8 | 40386      | 2022/8/23          | 2023/8/22           |
| Surge&EFT Generators<br>TESEQ                                    | NSG 3060   | 1572       | 2023/4/18          | 2024/4/17           |

Notes:

1. The test was performed in Linkou EMS Room No.02.
2. Tested Date: 2023/5/11

#### 4.11 Radio Frequency Common Mode (CS)

| Description<br>Manufacturer           | Model No.      | Serial No. | Calibrated<br>Date | Calibrated<br>Until |
|---------------------------------------|----------------|------------|--------------------|---------------------|
| CDN<br>FCC                            | FCC-801-M5-50A | 100018     | 2023/1/17          | 2024/1/16           |
| CDN<br>TESEQ                          | CDN S200       | 53490      | 2023/2/23          | 2024/2/22           |
|                                       | CDN S400       | 52115      | 2023/2/23          | 2024/2/22           |
| CDN Calibration Kit<br>TESEQ          | CDN T8S        | 29459      | 2023/2/21          | 2024/2/20           |
| CDN M2-16Amp<br>FCC                   | FCC-801-M2-16A | 01047      | 2023/2/22          | 2024/2/21           |
| Coupling Decoupling Network<br>TESEQ  | CDN M432S      | 56519      | 2023/2/22          | 2024/2/21           |
|                                       | CDN S751A      | 56435      | 2023/2/20          | 2024/2/19           |
|                                       |                | 56436      | 2023/2/21          | 2024/2/20           |
|                                       | CDN ST08A      | 56525      | 2023/2/20          | 2024/2/19           |
|                                       |                | 56527      | 2023/2/20          | 2024/2/19           |
|                                       | CDN T2A-10     | 54942      | 2023/2/21          | 2024/2/20           |
|                                       | CDN T8-10      | 40376      | 2023/2/21          | 2024/2/20           |
|                                       | CDN T8-230     | 56641      | 2023/2/21          | 2024/2/20           |
|                                       |                | 56642      | 2023/2/21          | 2024/2/20           |
| CDN T800                              | 34428          | 2023/2/21  | 2024/2/20          |                     |
| CDN T400A                             | 49918          | 2023/2/22  | 2024/2/21          |                     |
| Coupling/Dcoupling Network<br>EM TEST | CDN M1/32A     | 306508     | 2023/2/22          | 2024/2/21           |
| Coupling/Dcoupling Network<br>TESEQ   | CDN M232       | 37702      | 2023/2/22          | 2024/2/21           |
|                                       | CDN M332       | 41256      | 2023/2/22          | 2024/2/21           |
|                                       |                | 41258      | 2023/2/22          | 2024/2/21           |
| CS Power Amplifier<br>ETS-Lindgren    | 8100-010       | 00163535   | N/A                | N/A                 |
| Current Clamp<br>FCC                  | F-120-9A       | 361        | 2022/8/17          | 2023/8/16           |
| Ear Simulator Telephonometry<br>B&K   | 4185           | 2553594    | N/A                | N/A                 |
| FCC EM Injection Clamp<br>FCC         | F-203I-23mm    | 455        | N/A                | N/A                 |
| Mouth Simulator<br>B&K                | 4227           | 2630632    | N/A                | N/A                 |
| POWER AMPLIFIER<br>B&K                | 2716C          | 2610979    | N/A                | N/A                 |
| Power Meter<br>R & S                  | NRVD           | 837794/040 | 2022/10/18         | 2023/10/17          |
| Power Sensor<br>R & S                 | NRV-Z5         | 837878/039 | 2022/10/18         | 2023/10/17          |
| Pressure-field Microphone<br>B&K      | 4192           | 2735407    | N/A                | N/A                 |
| SIGNAL GENERATOR<br>R&S               | SML03          | 101364     | 2022/8/16          | 2023/8/15           |
| Software<br>BVADT                     | ABMS_ V7.4.3   | N/A        | N/A                | N/A                 |



| Description<br>Manufacturer                             | Model No.       | Serial No. | Calibrated<br>Date | Calibrated<br>Until |
|---|-----------------|------------|--------------------|---------------------|
| Software<br>BVADT                                       | BVADT_CS_V7.6.6 | N/A        | N/A                | N/A                 |
| Two channel microphone<br>conditioning amplifier<br>B&K | 2690 OS2        | 3001996    | 2022/11/15         | 2023/11/14          |
| Wireless Connection Tester<br>R&S                       | CMW270          | 101075     | N/A                | N/A                 |

Notes:

1. The test was performed in Linkou CS Room No.1.
2. Tested Date: 2023/5/11

#### 4.12 Power Frequency Magnetic Field (PFMF)

| Description<br>Manufacturer                     | Model No. | Serial No. | Calibrated<br>Date | Calibrated<br>Until |
|---|-----------|------------|--------------------|---------------------|
| Magnetic Field Meter<br>Combinova               | MFM 10    | 224        | 2022/10/18         | 2023/10/17          |
| Magnetic Field Test System<br>Haefely Trench AG | MAG 100   | 083794-06  | N/A                | N/A                 |

Notes:

1. The test was performed in Linkou EMS Room No.1.
2. Tested Date: 2023/5/10

#### 4.13 Voltage Dips and Interruptions (DIP)

| Description<br>Manufacturer             | Model No.     | Serial No.            | Calibrated<br>Date | Calibrated<br>Until |
|---|---------------|-----------------------|--------------------|---------------------|
| Harmonics and Flicker Analyzer<br>TESEQ | PROFLINE 2105 | 1632A00983&1639A01863 | 2022/6/8           | 2023/6/7            |
| Software                                | WIN2120       | N/A                   | N/A                | N/A                 |

Notes:

1. The test was performed in Linkou EMS Room No.1.
2. Tested Date: 2023/5/9

## 5 Limits of Test Items

### 5.1 Conducted Emissions from Power Ports

| Frequency (MHz) | Class A (dB $\mu$ V) |         | Class B (dB $\mu$ V) |         |
|-----------------|----------------------|---------|----------------------|---------|
|                 | Quasi-peak           | Average | Quasi-peak           | Average |
| 0.15 - 0.5      | 79                   | 66      | 66 - 56              | 56 - 46 |
| 0.50 - 5.0      | 73                   | 60      | 56                   | 46      |
| 5.0 - 30.0      | 73                   | 60      | 60                   | 50      |

Notes: 1. The lower limit shall apply at the transition frequencies.  
 2. The limit decreases linearly with the logarithm of the frequency in the range of 0.15 to 0.50 MHz.

### 5.2 Conducted Emissions from Wired Network Ports

| Frequency (MHz) | Coupling Device             | Class A                    |         |                             |         | Class B                    |         |                             |         |
|-----------------|-----------------------------|----------------------------|---------|-----------------------------|---------|----------------------------|---------|-----------------------------|---------|
|                 |                             | Voltage Limit (dB $\mu$ V) |         | Current limits (dB $\mu$ A) |         | Voltage Limit (dB $\mu$ V) |         | Current limits (dB $\mu$ A) |         |
|                 |                             | Quasi-peak                 | Average | Quasi-peak                  | Average | Quasi-peak                 | Average | Quasi-peak                  | Average |
| 0.15-0.5        | Using AAN                   | 97-87                      | 84-74   | -                           | -       | 84-74                      | 74-64   | -                           | -       |
| 0.5-30          |                             | 87                         | 74      | -                           | -       | 74                         | 64      | -                           | -       |
| 0.15-0.5        | Using CVP and Current probe | 97-87                      | 84-74   | 53-43                       | 40-30   | 84-74                      | 74-64   | 40-30                       | 30-20   |
| 0.5-30          |                             | 87                         | 74      | 43                          | 30      | 74                         | 64      | 30                          | 20      |
| 0.15-0.5        | Using a 150 $\Omega$ load   | -                          | -       | 53-43                       | 40-30   | -                          | -       | 40-30                       | 30-20   |
| 0.5-30          |                             | -                          | -       | 43                          | 30      | -                          | -       | 30                          | 20      |

Note: The limits decrease linearly with the logarithm of the frequency in the range 0.15 MHz to 0.5 MHz.

### 5.3 Radiated Emissions up to 1 GHz

| Frequency (MHz) | Class A Quasi-peak (dB $\mu$ V/m) |        | Class B Quasi-peak (dB $\mu$ V/m) |        |
|-----------------|-----------------------------------|--------|-----------------------------------|--------|
|                 | at 3m                             | at 10m | at 3m                             | at 10m |
| 30 - 230        | 50                                | 40     | 40                                | 30     |
| 230 - 1000      | 57                                | 47     | 47                                | 37     |

#### For radiated emissions from FM receivers only (Measurement Facility: OATS/SAC)

| Frequency (MHz) | Fundamental (dB $\mu$ V/m) |        | Harmonics (dB $\mu$ V/m) |        |
|-----------------|----------------------------|--------|--------------------------|--------|
|                 | at 3m                      | at 10m | at 3m                    | at 10m |
| 30 - 230        | 60                         | 50     | 52                       | 42     |
| 230 - 300       | 60                         | 50     | 52                       | 42     |
| 300 - 1000      | 60                         | 50     | 56                       | 46     |

Notes: 1. The lower limit shall apply at the transition frequencies.  
 2. Emission level (dB $\mu$ V/m) = 20 log Emission level ( $\mu$ V/m).  
 3. All emanations from a class A/B digital device or system, including any network of conductors and apparatus connected thereto, shall not exceed the level of field strengths specified above.

#### 5.4 Radiated Emissions above 1 GHz

| Frequency (GHz) | Class A (dBuV/m) (at 3m) |      | Class B (dBuV/m) (at 3m) |      |
|-----------------|--------------------------|------|--------------------------|------|
|                 | Average                  | Peak | Average                  | Peak |
| 1 to 3          | 56                       | 76   | 50                       | 70   |
| 3 to 6          | 60                       | 80   | 54                       | 74   |

- Notes: 1. The lower limit shall apply at the transition frequencies.  
 2. Emission level (dBuV/m) = 20 log Emission level (uV/m).  
 3. All emanations from a class A/B digital device or system, including any network of conductors and apparatus connected thereto, shall not exceed the level of field strengths specified above.

#### Frequency Range of Radiated Measurement (For unintentional radiators)

| Highest internal frequency ( $F_x$ )         | Highest measurement frequency ( $F_M$ ) (GHz) |
|--|---|
| $F_x \leq 108 \text{ MHz}$                   | 1   |
| $108 \text{ MHz} < F_x \leq 500 \text{ MHz}$ | 2   |
| $500 \text{ MHz} < F_x \leq 1 \text{ GHz}$   | 5   |
| $F_x > 1 \text{ GHz}$                        | $5 \times F_x$ up to a maximum of 6 GHz       |

$F_x$  is the highest fundamental frequency generated and/or used in the ITE or digital apparatus under test.

#### 5.5 Harmonic Current Measurement

| Limits for Class A equipment |                                      | Limits for Class D equipment |  |                                      |
|------------------------------|--------------------------------------|------------------------------|--|--------------------------------------|
| Harmonic Order $n$           | Max. permissible harmonics current A | Harmonic Order $n$           | Max. permissible harmonics current per watt mA/W | Max. permissible harmonics current A |
| Odd harmonics                |                                      | Odd Harmonics only           |  |                                      |
| 3                            | 2.30                                 | 3                            | 3.4  | 2.30                                 |
| 5                            | 1.14                                 | 5                            | 1.9  | 1.14                                 |
| 7                            | 0.77                                 | 7                            | 1.0  | 0.77                                 |
| 9                            | 0.40                                 | 9                            | 0.5  | 0.40                                 |
| 11                           | 0.33                                 | 11                           | 0.35   | 0.33                                 |
| 13                           | 0.21                                 | 13                           | 0.30   | 0.21                                 |
| $15 \leq n \leq 39$          | $0.15 \times 15/n$                   | $15 \leq n \leq 39$          | $3.85/n$   | $0.15 \times 15/n$                   |
| Even harmonics               |                                      |                              |  |                                      |
| 2                            | 1.08                                 |                              |  |                                      |
| 4                            | 0.43                                 |                              |  |                                      |
| 6                            | 0.30                                 |                              |  |                                      |
| $8 \leq n \leq 40$           | $0.23 \times 8/n$                    |                              |  |                                      |

- Notes: 1. Class A and Class D are classified according to section 5 of EN 61000-3-2.  
 2. According to section 7 of EN 61000-3-2, the above limits for all equipment except for lighting equipment having an active input power > 75 W and no limits apply for equipment with an active input power up to and including 75 W.

#### Classification of equipment

| Class A   | Class B   | Class C             | Class D  |
|---|---|---------------------|--|
| Balanced three-phase equipment;<br>Household appliances excluding equipment as Class D;<br>Tools excluding portable tools;<br>Dimmers for incandescent lamps;<br>Audio equipment;<br>Equipment not specified in one of the three other classes. | Portable tools;<br>Arc welding equipment which is not professional equipment. | Lighting equipment. | Equipment having a specified power less than or equal to 600 W of the following types:<br>Personal computers and personal computer monitors;<br>Television receivers;<br>Refrigerators and freezers having one or more variable-speed drives to control compressor motor(s). |

## 5.6 Voltage Fluctuations and Flicker Measurement

| Test Item     | Limit | Note  |
|---------------|-------|---|
| $P_{st}$      | 1.0   | $P_{st}$ means short-term flicker indicator.  |
| $P_{lt}$      | 0.65  | $P_{lt}$ means long-term flicker indicator.   |
| $T_{dt}$ (ms) | 500   | $T_{dt}$ means maximum time that $d(t)$ exceeds 3.3 %.  |
| $d_c$ (%)     | 3.3%  | $d_c$ means relative steady-state voltage change<br>$d_{max}$ means maximum relative voltage change.<br>Control Method of Equipment (see below)   |
| $d_{max}$ (%) | 4%    | <input checked="" type="checkbox"/> - without additional conditions   |
|               | 6%    | <input type="checkbox"/> - switched manually, or<br>- switched automatically more frequently than twice per day, and also has either a delayed restart (the delay not less than a few tens of seconds), or manual restart, after a power supply interruption  |
|               | 7%    | <input type="checkbox"/> - attended whilst in use (for example: hair dryers, vacuum cleaners, kitchen equipment such as mixers, garden equipment such as lawn mowers, portable tools such as electric drills), or switched on automatically, or<br>- is intended to be switched on manually, no more than twice per day, and also has either a delayed restart ( the delay being not less than a few tens of seconds) or manual restart, after a power supply interruption. |

## 5.7 General immunity requirements

For EN 55035

| Port   | Basic Standard | Test item   | Test specification   | Performance criteria  |   |
|--|----------------|---|--|---|---|
| Power input (AC)                                       | IEC 61000-4-4  | Fast Transients, Common Mode (EFT)                                    | ±1 kV<br>5/50 ns (Tr/Th)<br>5 kHz, repetition frequency  | B   |   |
|  | IEC 61000-4-5  | Surge   | Line to line: ±1 kV, 1.2/50 µs<br>Line to earth: ±2 kV, 1.2/50 µs  | B   |   |
|  | IEC 61000-4-6  | Radio Frequency, Common Mode (CS)                                     | 0.15-10 MHz, 3 V, 80% AM (1 kHz),<br>10-30 MHz, 3 V-1 V, 80% AM (1 kHz),<br>30-80 MHz, 1 V, 80% AM (1 kHz),  | A   |   |
|  | IEC 61000-4-11 | Voltage dips and interruptions (DIP)                                  | <b>Voltage Dips:</b><br>< 5% residual voltage, 0.5 cycle<br>70% residual voltage, 25 cycles (at 50 Hz)<br><b>Voltage Interruption:</b><br>< 5% residual voltage, 250 cycles (at 50 Hz)   | B<br>C<br>C   |   |
| DC power/<br>Wired network and Signal/<br>Control port | IEC 61000-4-4  | Fast Transients, Common Mode (EFT)                                    | ±0.5 kV<br>5/50 ns (Tr/Th)<br>100 kHz, repetition frequency for xDSL port<br>5 kHz, repetition frequency for other port  | B   |   |
|  | IEC 61000-4-5  | Surge   | <b>Wired network ports</b> (directly connected to outdoor cables):<br>Symmetrically operated: 10/700 µs<br>w/o primary protectors: ±1.0 kV, or<br>with primary protectors fitted: ±1.0 kV and ±4.0 kV,<br>Coaxial or shielded operated: 1.2/50 µs<br>shield to ground: ±0.5 kV,  | C<br>B  |   |
|  |                |   | <b>DC power ports</b> (directly connected to outdoor cables): 1.2/50 µs<br>each individual line to earth, or<br>shield to ground: ±0.5 kV,   | B   |   |
|  |                |   |  |   |   |
|  | IEC 61000-4-6  | Broadband impulse noise disturbances (Applicable only to xDSL ports.) | Radio Frequency, Common Mode (CS)  | 0.15-10 MHz, 3 V, 80% AM (1 kHz),<br>10-30 MHz, 3 V-1 V, 80% AM (1 kHz),<br>30-80 MHz, 1 V, 80% AM (1 kHz), | A |
|  |                |   | <b>Repetitive :</b><br>Impulse frequency profile :<br>0.15 – 0.5 MHz, 107 dBuV ;<br>0.5 – 10 MHz, 107 – 36 dBuV ;<br>10 – 30 MHz, 36 – 30 dBuV<br>Burst duration : 0.70 ms<br>Burst period : 10 ms (for 50 Hz)<br>At least 2 minutes for each port under test.<br><b>Isolated :</b><br>Impulse frequency profile :<br>0.15 – 30 MHz, 110 dBuV<br>Burst duration : 0.24 ms, 10 ms and 300 ms<br>Isolated impulses : 5 times<br>Interval : at least 60 seconds | A<br>B  |   |

| Port      | Basic Standard | Test item                                  | Test specification  | Performance criteria |
|-----------|----------------|--|---|----------------------|
| Enclosure | IEC 61000-4-2  | Electrostatic Discharge (ESD)              | ±4 kV (contact)<br>±8 kV (Air)  | B                    |
|           | IEC 61000-4-3  | Radio Frequency Electromagnetic Field (RS) | Swept Frequency Test:<br>80 to 1000(MHz), 3 V/m, 80% AM (1 kHz)<br>Spot Frequency Test:<br>1800, 2600, 3500, 5000 MHz (±1%),<br>3 V/m, 80% AM (1 kHz) | A                    |
|           | IEC 61000-4-8  | Power Frequency Magnetic Field (PFMF)      | 1 A/m, 50 Hz  | A                    |





## 6.2 Conducted Emissions from Wired Network Ports

### Method of Using AANs:

- The EUT is placed 0.4 meters from the conducting wall of the shielded room and connected to AAN directly to reference ground plane.
- If voltage measurement is used, measure voltage at the measurement port of the AAN, correct the reading by adding the AAN voltage division factor, and compare to the voltage limit.
- It is not necessary to apply the current limit if a AAN is used.
- The test results of disturbance at telecommunication ports are recorded of six worst margins for quasi-peak (mandatory) [and average (if necessary)] values against the limits at frequencies of interest unless the margin is 20 dB or greater.

Note: The resolution bandwidth and video bandwidth of test receiver is 9kHz for quasi-peak detection (QP) and average detection (AV) at frequency 0.15MHz-30MHz.

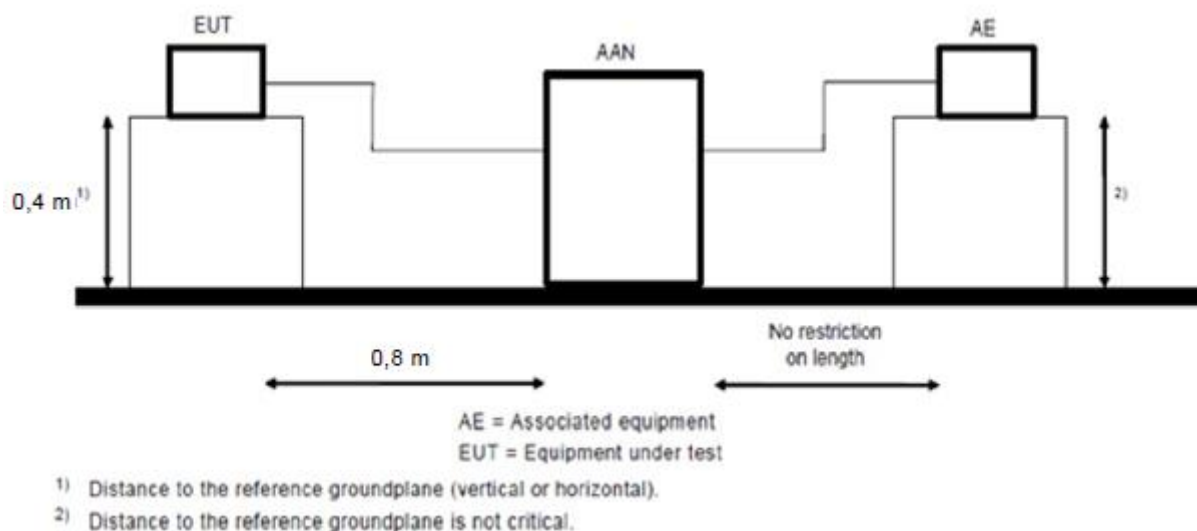

For the actual test configuration, please refer to the related Item – Photographs of the Test Configuration.

### Method of Using a 150 $\Omega$ load to the outside surface of the shielding cable:

- Breaks the external protective insulation (exposing the shield) and connect a 150 $\Omega$  resistor from the outside surface of the shield to ground.
- A current probe shall be placed at 0.1 m from the 150 $\Omega$  resistor. The current probe to EUT horizontal distance is between 0.3 m to 0.8 m.
- If current measurement is used, measure current at the measurement port of the current probe, correct the reading by adding the current probe division factor, and compare to the current limit.
- It is not necessary to apply the voltage limit if a current probe is used.
- The test results of disturbance at telecommunication ports are recorded of six worst margins for quasi-peak (mandatory) [and average (if necessary)] values against the limits at frequencies of interest unless the margin is 20 dB or greater.

Note: The resolution bandwidth and video bandwidth of test receiver is 9kHz for quasi-peak detection (QP) and average detection (AV) at frequency 0.15MHz-30MHz.

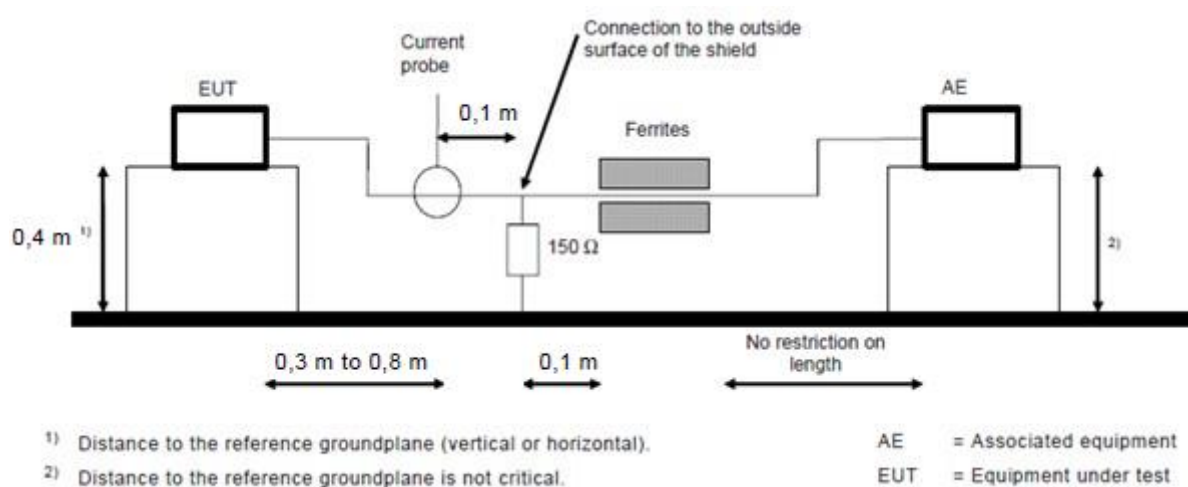

For the actual test configuration, please refer to the related Item – Photographs of the Test Configuration.

### Method of Using a combination of current probe and capacitive voltage probe:

- a. Measure current with a current probe.
- b. Compare the measured current with the applicable current limit.
- c. Measure voltage with a capacitive voltage probe as specified in 5.2.2 of CISPR 16-1-2.
- d. Adjust the measured voltage as follows:
  - current margin  $\leq 6$  dB – subtract the actual current margin from measured voltage;
  - current margin  $> 6$  dB – subtract 6 dB from measured voltage.
- e. Compare adjusted voltage with the applicable voltage limit
- f. Both the measured current and the adjusted voltage shall be below the applicable
- g. The test results of disturbance at telecommunication ports are recorded of six worst margins for quasi-peak (mandatory) [and average (if necessary)] values against the limits at frequencies of interest unless the margin is 20 dB or greater.

Note: The resolution bandwidth and video bandwidth of test receiver is 9kHz for quasi-peak detection (QP) and average detection (AV) at frequency 0.15MHz-30MHz.

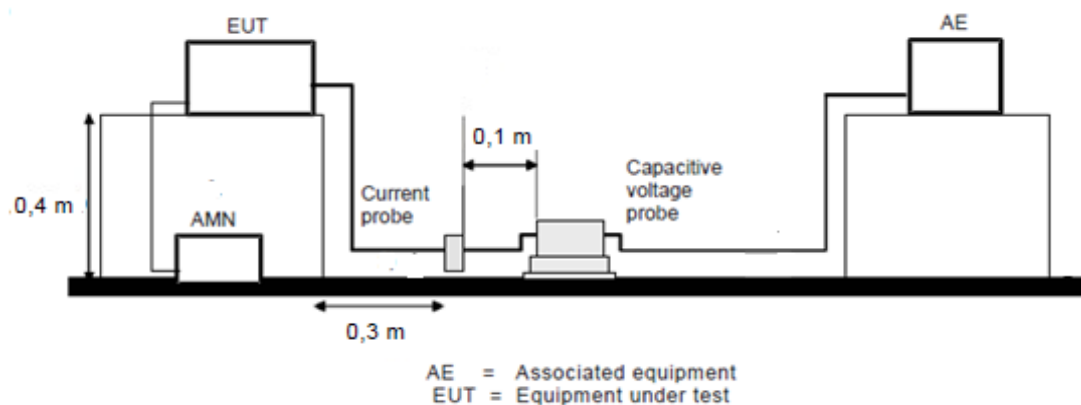

For the actual test configuration, please refer to the related Item – Photographs of the Test Configuration.

### 6.3 Radiated Emissions up to 1 GHz

- For the table-top EUT is placed on a 0.8 meter to the top of rotating table; for the floor standing EUT shall be insulated (by insulation of maximum thickness of 150 mm) from the horizontal reference ground plane. The rotating table is rotated 360 degrees to determine the position of the highest radiation. If the equipment requires a dedicated ground connection, this shall be provided and bonded to the RGP.
- The EUT is set 10 meters away from the interference-receiving antenna, which is mounted on the top of a variable-height antenna tower.
- The antenna is a broadband antenna, and its height is varied from one meter to four meters above the ground to determine the maximum value of the field strength. Both horizontal and vertical polarizations of the antenna are set to make the measurement.
- For each suspected emission, the EUT is arranged to its worst case and then the antenna is tuned to heights from 1 m to 4 m and the rotatable table was turned from 0 degrees to 360 degrees to find the maximum reading.
- The test-receiver system is set to quasi-peak detect function and specified bandwidth with maximum hold mode when the test frequency is up to 1 GHz.

Note: The resolution bandwidth and video bandwidth of test receiver/spectrum analyzer is 120kHz for quasi-peak detection (QP) at frequency up to 1GHz.

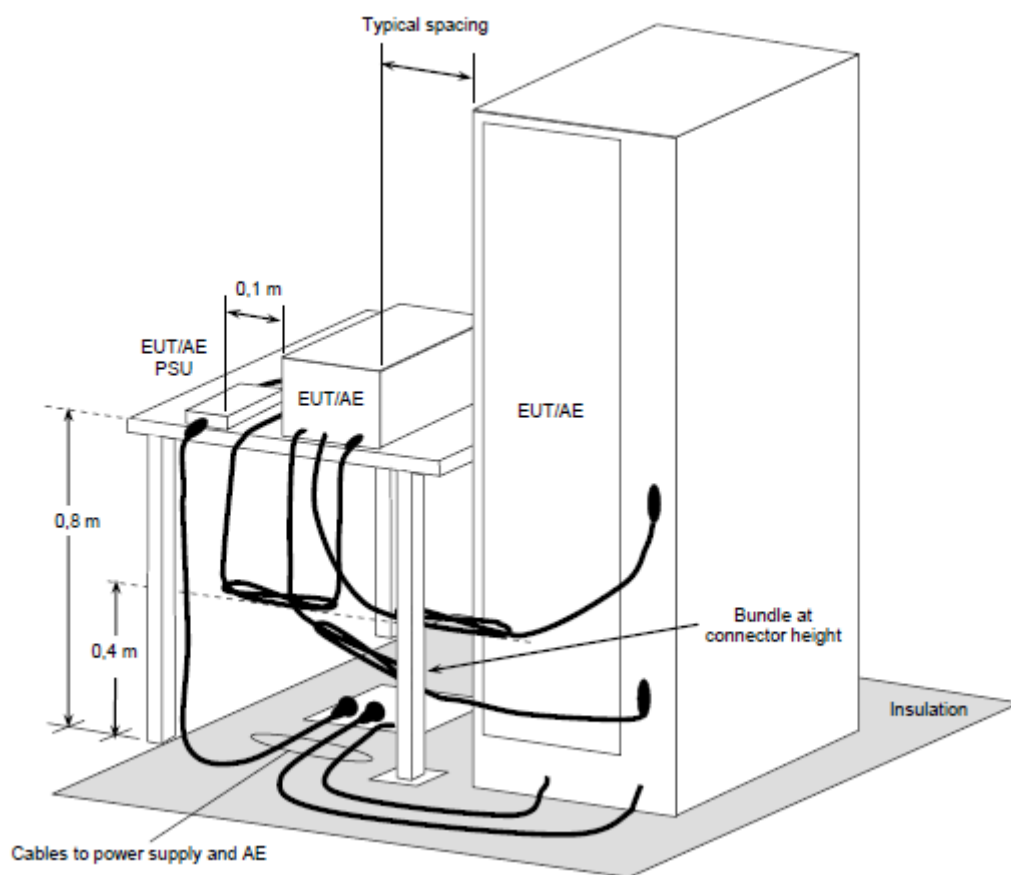

For the actual test configuration, please refer to the related Item – Photographs of the Test Configuration.

## 6.4 Radiated Emissions above 1 GHz

- For the table-top EUT is placed on a 0.8 meter to the top of rotating table; for the floor standing EUT shall be insulated (by insulation of 12 mm) from the horizontal reference ground plane. The rotating table is rotated 360 degrees to determine the position of the highest radiation. If the equipment requires a dedicated ground connection, this shall be provided and bonded to the RGP.
- The EUT was set  $d = 3$  meters away from the interference-receiving antenna, which was mounted on the top of a variable-height antenna tower.
- The height of antenna can be varied from one meter to four meters, the height of adjustment depends on the EUT height and the antenna 3dB beamwidth both, to detect the maximum value of the field strength. Both horizontal and vertical polarizations of the antenna are set to make the measurement.
- For each suspected emission, the EUT was arranged to its worst case and then the antenna was tuned to heights and the rotatable table was turned from 0 degrees to 360 degrees to find the maximum reading.
- The spectrum analyzer system was set to peak and average detects function and specified bandwidth with maximum hold mode when the test frequency is above 1 GHz.

Note: The resolution bandwidth of test receiver/spectrum analyzer is 1MHz and video bandwidth is 3MHz for Peak detection (PK) at frequency above 1GHz. The resolution bandwidth of test receiver/spectrum analyzer is 1 MHz for Average detection (AV) at frequency above 1GHz.

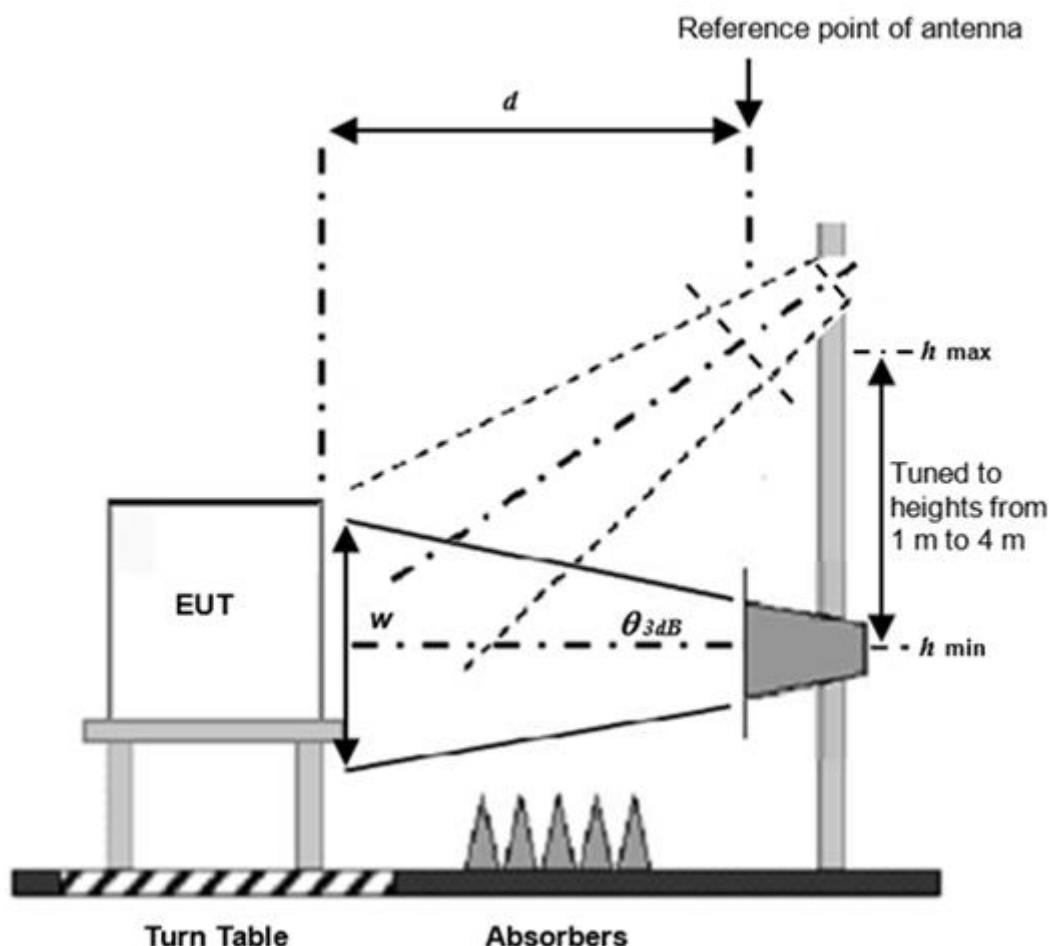

For the actual test configuration, please refer to the related item – Photographs of the Test Configuration.

## 6.5 Harmonic Current Measurement

- The harmonic current limits apply to line currents and not to currents in the neutral conductor. Nevertheless, for single-phase equipment, it is permissible to measure the currents in the neutral conductor instead of the currents in the line.
- The EUT is tested as presented by, and in accordance with information provided by, the manufacturer. Preliminary operation of motor drives by the manufacturer may be needed before the tests are undertaken to ensure that results correspond with normal use.
- In all configurations, the use of additional load shall not cause the total output power available to be exceeded.
- The correspondent test program of test instrument to measure the current harmonics emanated from EUT is chosen. The measure time shall be not less than the time necessary for the EUT to be exercised.

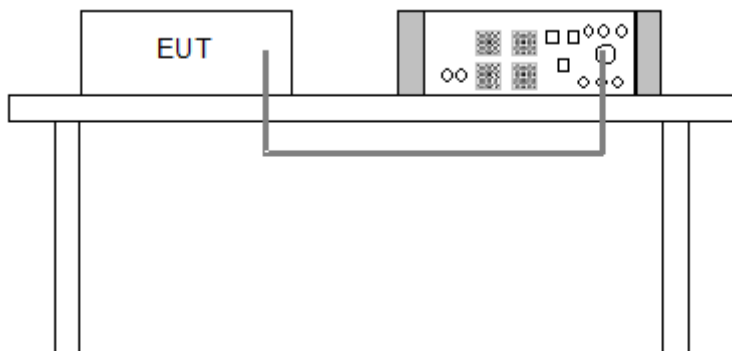

For the actual test configuration, please refer to the related Item – Photographs of the Test Configuration.

## 6.6 Voltage Fluctuations and Flicker Measurement

- Controls or automatic programs of the EUT shall be set to produce the most unfavourable sequence of voltage changes, using only those combinations of controls and programmes which are mentioned by the manufacturer in the instruction manual, or are otherwise likely to be used.
- Preliminary operation of motor drives may be needed before the tests to ensure that results corresponding to those of normal use are obtained.
- During the flick measurement, the measure time shall include that part of whole operation cycle in which the EUT produce the most unfavorable sequence of voltage changes. The observation period for short-term flicker indicator is 10 minutes and the observation period for long-term flicker indicator is 2 hours.

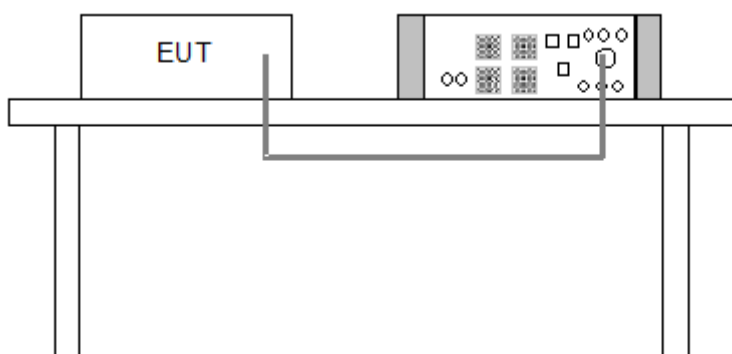

For the actual test configuration, please refer to the related Item – Photographs of the Test Configuration.

## 6.7 Electrostatic Discharges (ESD)

|                             |   |
|-----------------------------|---|
| <b>Discharge Impedance:</b> | 330 ohm / 150 pF  |
| <b>Number of Discharge:</b> | Air – Direct: 10 discharges per location (each polarity)<br>Contact – Direct & Indirect: 10 discharges per location (each polarity) |
| <b>Discharge Period:</b>    | 1-second minimum  |

The basic test procedure was in accordance with EN/IEC 61000-4-2:

- a. Electrostatic discharges were applied only to those points and surfaces of the EUT that are accessible to users during normal operation.
- b. The test was performed with at least ten single discharges on the pre-selected points in the most sensitive polarity.
- c. The time interval between two successive single discharges was at least 1 second.
- d. The ESD generator was held perpendicularly to the surface to which the discharge was applied and the return cable was at least 0.2 meters from the EUT.
- e. Contact discharges were applied to the non-insulating coating, with the pointed tip of the generator penetrating the coating and contacting the conducting substrate.
- f. Air discharges were applied with the round discharge tip of the discharge electrode approaching the EUT as fast as possible (without causing mechanical damage) to touch the EUT. After each discharge, the ESD generator was removed from the EUT and re-triggered for a new single discharge. The test was repeated until all discharges were complete.
- g. At least ten single discharges (in the most sensitive polarity) were applied to the **Horizontal Coupling Plane** at points on each side of the EUT. The ESD generator was positioned at a distance of 0.1 meters from the EUT with the discharge electrode touching the **HCP**.
- h. At least ten single discharges (in the most sensitive polarity) were applied to the center of one vertical edge of the **Vertical Coupling Plane** in sufficiently different positions that the four faces of the EUT were completely illuminated. The **VCP** (dimensions 0.5m x 0.5m) was placed vertically to and 0.1 meters from the EUT.



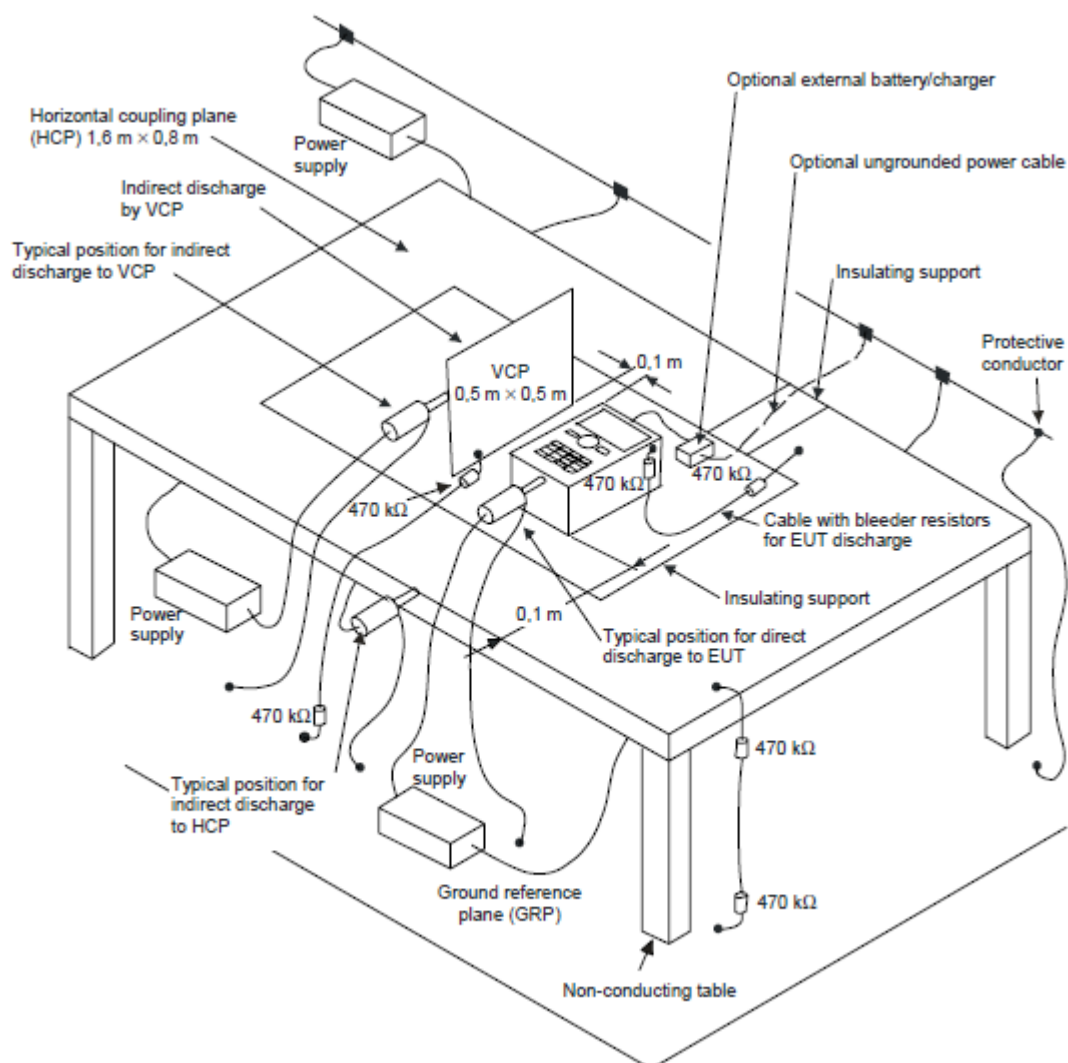

For the actual test configuration, please refer to the related item – Photographs of the Test Configuration.

**NOTE:**

**TABLE-TOP EQUIPMENT**

The configuration consisted of a wooden table 0.8 meters high standing on the **Ground Reference Plane**. The **GRP** consisted of a sheet of aluminum at least 0.25mm thick, and 2.5 meters square connected to the protective grounding system. A **Horizontal Coupling Plane** (1.6m x 0.8m) was placed on the table and attached to the **GRP** by means of a cable with 940kΩ total impedance. The equipment under test, was installed in a representative system as described in section 7 of EN/IEC 61000-4-2, and its cables were placed on the **HCP** and isolated by an insulating support of 0.5mm thickness. A distance of 1-meter minimum was provided between the EUT and the walls of the laboratory and any other metallic structure.

**FLOOR-STANDING EQUIPMENT**

The equipment under test was installed in a representative system as described in section 7 of IEC 61000-4-2, and its cables were isolated from the Ground Reference Plane by an insulating support of 0.1-meter thickness. The **GRP** consisted of a sheet of aluminum that is at least 0.25mm thick, and 2.5 meters square connected to the protective grounding system and extended at least 0.5 m.

## 6.8 Radio Frequency Electromagnetic Field (RS)

|                 |                                    |
|-----------------|------------------------------------|
| Modulation:     | 1kHz Sine Wave, 80%, AM Modulation |
| Frequency Step: | 1 % of preceding frequency value   |
| Dwell Time:     | 3 seconds                          |

The test procedure was in accordance with EN/IEC 61000-4-3.

- The testing was performed in a modified semi-anechoic chamber.
- The frequency range shall be swept, with the signal 80% amplitude modulated with a 1kHz sine wave.
- The test was performed with the EUT exposed to both vertically and horizontally polarized fields on each of the four sides.

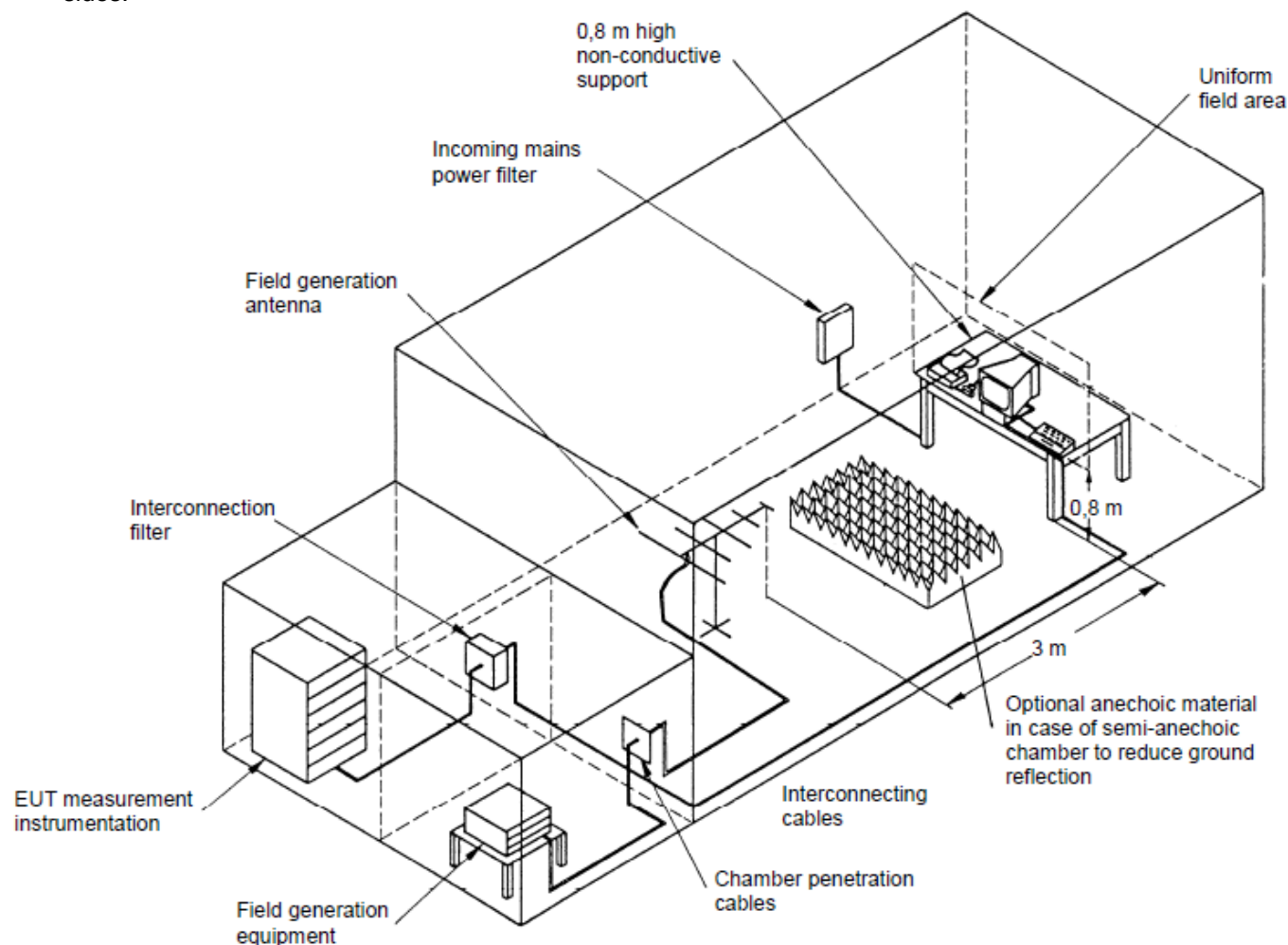

For the actual test configuration, please refer to the related item – Photographs of the Test Configuration.

### NOTE:

#### **TABLETOP EQUIPMENT**

The EUT installed in a representative system as described in section 7 of EN/IEC 61000-4-3 was placed on a non-conductive table 0.8 meters in height. The system under test was connected to the power and signal wire according to relevant installation instructions.

#### **FLOOR STANDING EQUIPMENT**

The EUT installed in a representative system as described in section 7 of EN/IEC 61000-4-3 was placed on a non-conductive wood support 0.1 meters in height. The system under test was connected to the power and signal wire according to relevant installation instructions.

## 6.9 Fast Transients Common Mode (EFT)

|                               |  |
|-------------------------------|--|
| Impulse Repetition Frequency: | xDSL telecommunication port: 100kHz<br>others: 5kHz                            |
| Impulse Wave Shape:           | 5/50 ns  |
| Burst Duration:               | 0.75 ms for 100kHz Repetition Frequency<br>15 ms for 5kHz Repetition Frequency |
| Burst Period:                 | 300 ms   |
| Test Duration:                | 1 min.   |

- Both positive and negative polarity discharges were applied.
- The distance between any coupling devices and the EUT should be 0.5 m for table-top equipment testing, and 1.0 m for floor standing equipment.
- The duration time of each test sequential was 1 minute.
- The transient/burst waveform was in accordance with EN/IEC 61000-4-4, 5/50 ns.

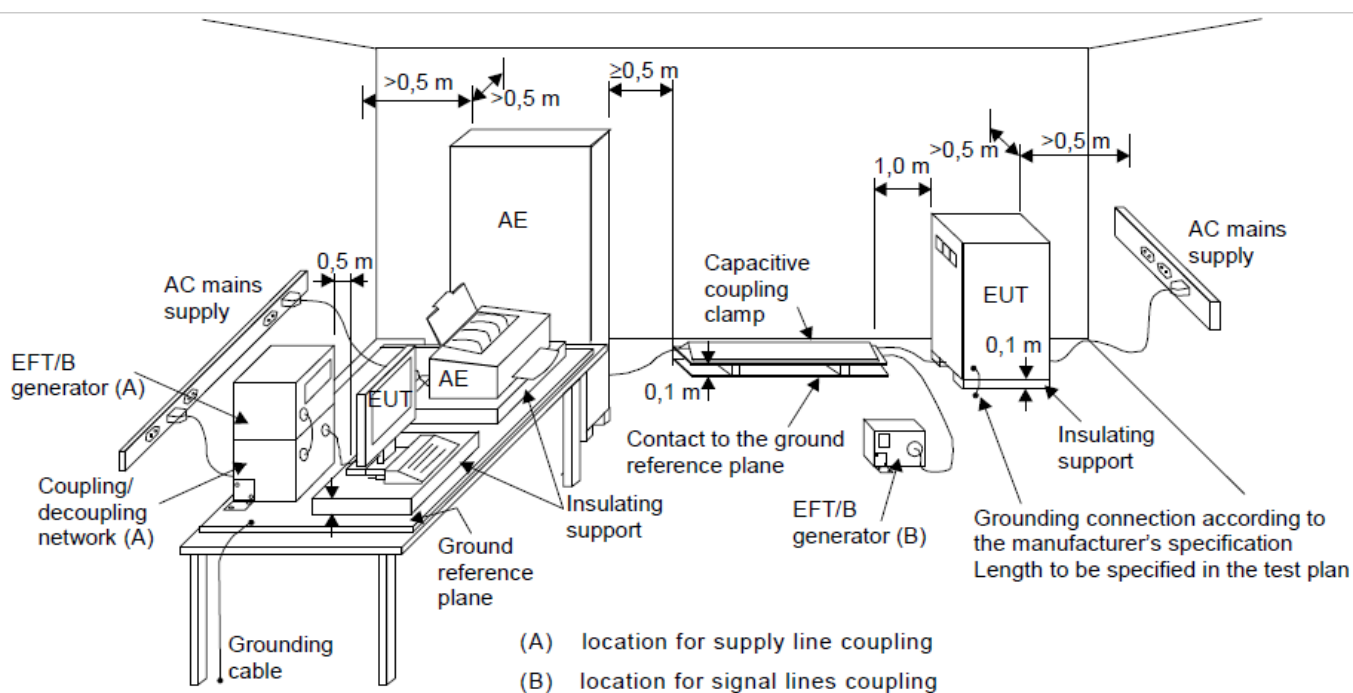

For the actual test configuration, please refer to the related item – Photographs of the Test Configuration.

## 6.10 Surges

|                        |  |
|------------------------|--|
| Wave-Shape:            | <b>Wired network ports (direct to outdoor cables):</b><br><b>Symmetrically operated:</b><br>10/700 $\mu$ s Open Circuit Voltage<br>5/320 $\mu$ s Short Circuit Current<br><b>Non-symmetrically operated:</b><br>1.2/50 $\mu$ s Open Circuit Voltage<br>8/20 $\mu$ s Short Circuit Current<br><b>Shielded cables (direct to outdoor cables):</b><br>1.2/50 $\mu$ s Open Circuit Voltage<br>8/20 $\mu$ s Short Circuit Current<br><b>Wired network ports (indoor cables, longer than 30m):</b><br>1.2/50 $\mu$ s Open Circuit Voltage<br>8/20 $\mu$ s Short Circuit Current<br><b>Input DC power port (direct to outdoor cables):</b><br>1.2/50 $\mu$ s Open Circuit Voltage<br>8/20 $\mu$ s Short Circuit Current<br><b>Input AC power port:</b><br>1.2/50 $\mu$ s Open Circuit Voltage<br>8/20 $\mu$ s Short Circuit Current |
| Pulse Repetition Rate: | 20 sec.  |
| Number of Tests:       | 5 positive and 5 negative at selected points   |

### a. EUT Power ports:

The surge shall be applied to the EUT power supply terminals via the capacitive coupling network. Decoupling networks are required in order to avoid possible adverse effects on equipment not under test that may be powered by the same lines and to provide sufficient decoupling impedance to the surge wave. The power cord between the EUT and the coupling network shall not exceed 2 meters in length.

For double-insulated products without PE or external earth connections, the test shall be done in a similar way as for grounded products but without adding any additional external grounded connections. If there are no other possible connections to earth, line-to-ground tests may be omitted.

### b. Wired network ports

- Unshielded unsymmetrical interconnection lines:

The coupling / decoupling networks shall not influence the specified functional conditions of the EUT. The interconnection line between the EUT and the coupling network shall not exceed 2 meters in length.

No line-to-ground surges are applied for double-insulated products (i.e. products without any dedicated earth terminal).

- Unshielded symmetrical interconnection lines:

For symmetrical interconnection lines and high-speed interconnection lines, the CDN shall be selected to match the number of lines/pairs existing the cable. If coupling arrestors are use, test levels below the ignition point of the coupling arrestor cannot be specified.

The interconnection line between the EUT and the coupling/decoupling networks shall not exceed 2 meters in length.

In order to avoid the coupling and decoupling capacitors having a filtering effect on the data transfer, a balanced high frequency design associating the coupling capacitors with coupling chokes is required. Where normal functioning of high speed communications lines cannot be achieved because of the impact of the CDN on the EUT, product committees should specify appropriate operation or that no surge immunity test is required.

- Shielded lines:

The EUT is isolated from ground and the surge is applied to its metallic enclosure; the termination (or auxiliary equipment) at the port(s) under test is grounded. This test applies to equipment with one or more shielded cables.

The length of the cable between the port(s) under test and the device attached to the other end of the cable (AE in Figure 12) shall be:

- 20 m (preferred length) or,
- the shortest length over 10 m, where the manufacturer provides pre-assembled cables used in actual installations.

No test shall be required for cables which according to the manufacturer's specification are  $\leq 10$  m.

Rules for application of the surge to shielded lines:

- a) Shields grounded at both ends:  
– the test shall be carried out.

The test level is applied on shields with a  $2\ \Omega$  generator source impedance and with the  $18\ \mu\text{F}$  capacitor.

- b) Shields grounded at one end:  
– the test shall be carried out according to unshielded unsymmetrical interconnection lines or unshielded symmetrical interconnection lines because the shield does not provide any protection against surges induced by magnetic fields.

For EUTs which do not have metallic enclosures, the surge is applied directly to the shielded cable at the EUT side.

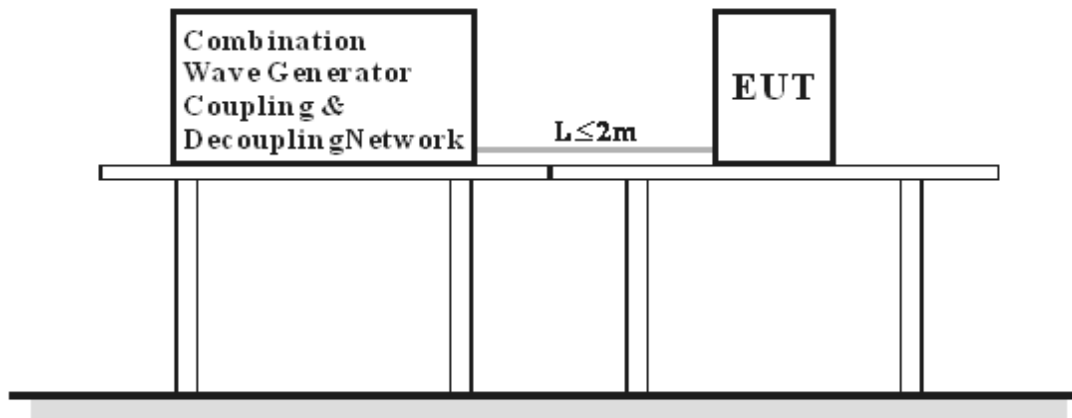

For the actual test configuration, please refer to the related item – Photographs of the Test Configuration.

## 6.11 Radio Frequency Common Mode (CS)

|                        |                                    |
|------------------------|------------------------------------|
| <b>Modulation:</b>     | 1kHz Sine Wave, 80%, AM Modulation |
| <b>Frequency Step:</b> | 1 % of preceding frequency value   |
| <b>Dwell Time</b>      | 3 seconds                          |

- The EUT shall be tested within its intended operating and climatic conditions.
- An artificial hand was placed on the hand-held accessory and connected to the ground reference plane.
- One of the CDNs not used for injection was terminated with 50 ohm, providing only one return path. All other CDNs were coupled as decoupling networks.
- The frequency range shall be swept, using the signal level established during the setting process and with a disturbance signal of 80 % amplitude. The signal is modulated with a 1 kHz sine wave, pausing to adjust the RF signal level or the switch coupling devices as necessary. Where the frequency is swept incrementally, the step size shall not exceed 1 % of the preceding frequency value.
- Attempts should be made to fully exercise the EUT during testing, and to fully interrogate all exercise modes selected for susceptibility.

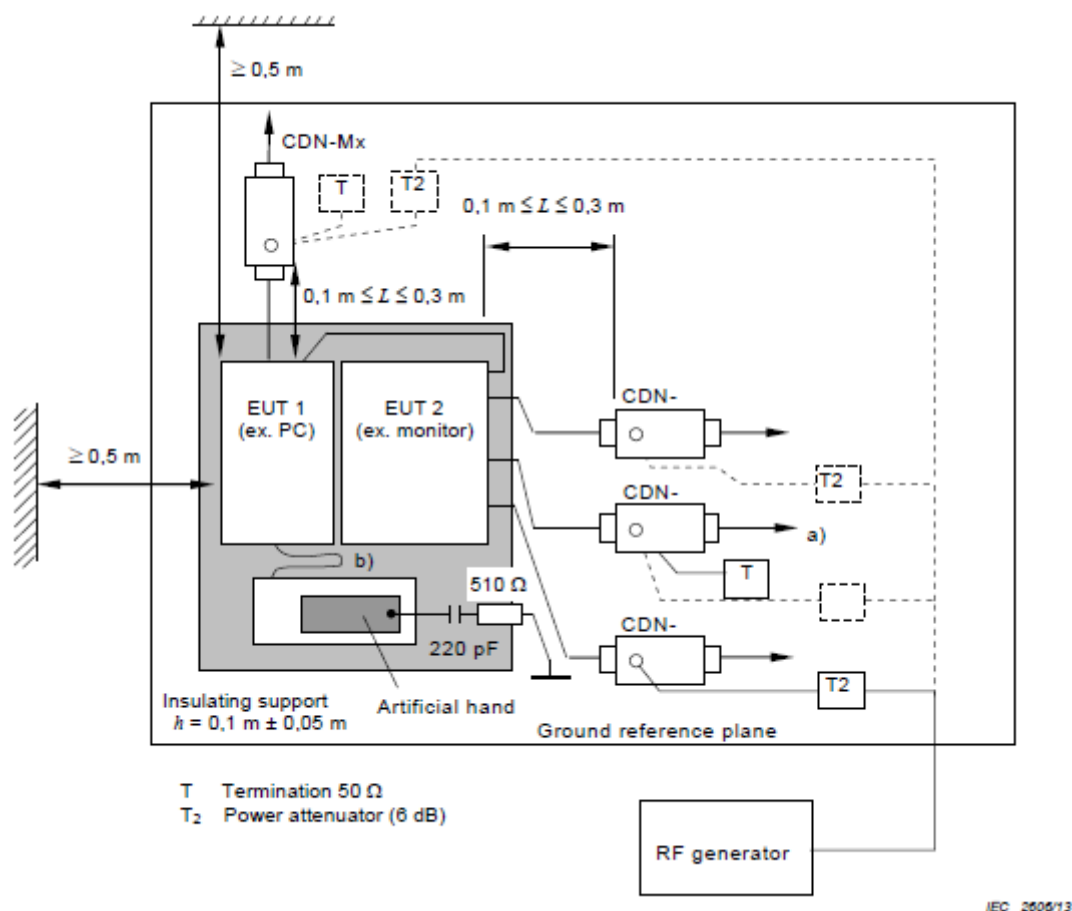

- Note:**
- The EUT clearance from any metallic obstacles shall be at least 0,5 m.
  - Interconnecting cables ( $\leq 1$  m) belonging to the EUT shall remain on the insulating support.
- For the actual test configuration, please refer to the related item – Photographs of the Test Configuration.

**Broadband impulse noise disturbances, Repetitive and Isolated** (Applicable only to xDSL ports.)

- a. The EUT shall be tested within its intended operating and climatic conditions.
- b. An artificial hand was placed on the hand-held accessory and connected to the ground reference plane.
- c. One of the CDNs not used for injection was terminated with 50 ohm, providing only one return path. All other CDNs were coupled as decoupling networks.
- d. For the repetitive impulse test the disturbance shall be applied for a period of at least 2 minutes for each port under test.
- e. For the isolated impulse test a minimum of 5 isolated impulses shall be applied with an interval of at least 60 seconds between successive impulses.
- f. Attempts should be made to fully exercise the EUT during testing, and to fully interrogate all exercise modes selected for susceptibility.

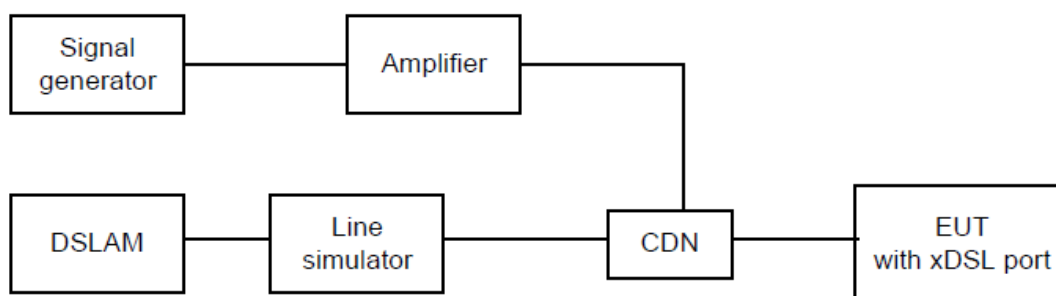

**Example schematic of the broadband impulsive conducted disturbances test setup**

For the actual test configuration, please refer to the related item – Photographs of the Test Configuration.

## 6.12 Power Frequency Magnetic Field (PFMF)

|                          |  |
|--------------------------|--|
| <b>Observation Time:</b> | 1 minute   |
| <b>Inductance Coil:</b>  | Rectangular coil, 1 m x 1 m (L x W) or 2.6 m x 1 m (L x W) |

- The equipment is configured and connected to satisfy its functional requirements.
- The power supply, input and output circuits shall be connected to the sources of power supply, control and signal.
- The cables supplied or recommended by the equipment manufacturer shall be used. 1 meter of all cables used shall be exposed to the magnetic field.

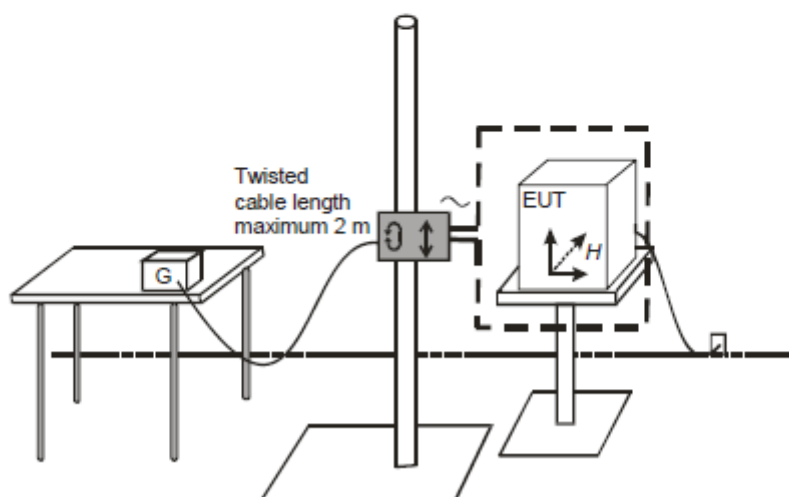
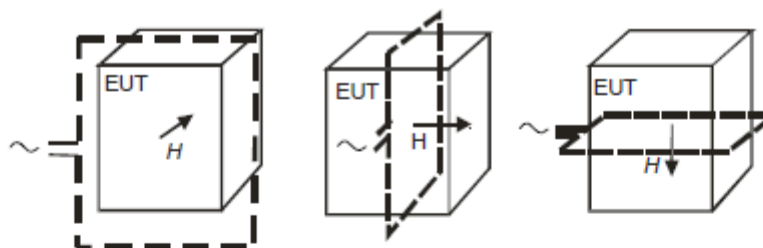

For the actual test configuration, please refer to the related item – Photographs of the Test Configuration.



### 6.13 Voltage Dips and Interruptions (DIP)

|                         |            |
|-------------------------|------------|
| Interval between Event: | 10 seconds |
| Sync Angle (degrees):   | 0° / 180°  |
| Test Cycle:             | 3 times    |

- a. The test shall be performed with the EUT connected to the test generator with the shortest power supply cable as specified by the EUT manufacturer. If no cable length is specified, it shall be the shortest possible length suitable to the application of the EUT.
- b. The EUT shall be tested for each selected combination of test levels and duration with a sequence of 3 dips/interruptions with intervals of 10 s minimum (between each test event). Each representative mode of operation shall be tested. Abrupt changes in supply voltage shall occur at 0 voltage crossover point of the voltage waveform.

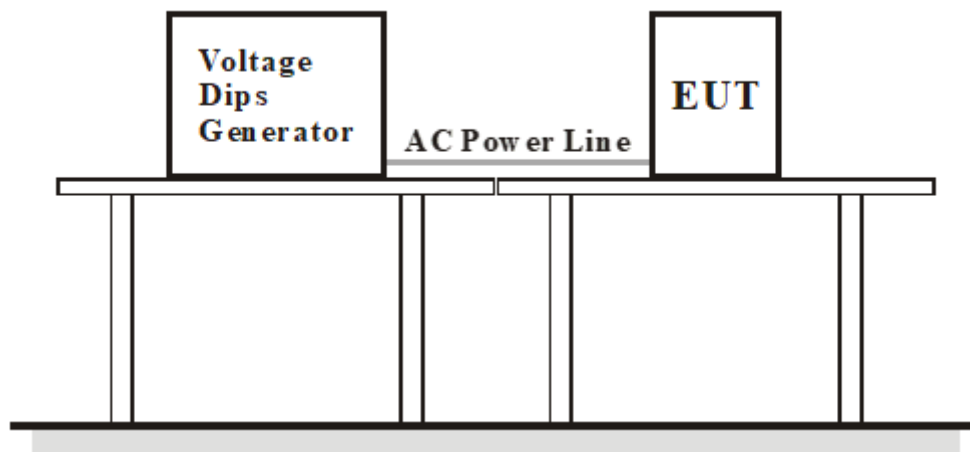

For the actual test configuration, please refer to the related item – Photographs of the Test Configuration.

## 7 Test Results of Test Item

### 7.1 Conducted Emissions from Power Ports

#### Mode A

|                 |                  |  |                                      |
|-----------------|------------------|--|--------------------------------------|
| Frequency Range | 150 kHz ~ 30 MHz | Detector Function & Resolution Bandwidth | Quasi-Peak (QP) / Average (AV), 9kHz |
| Input Power     | 110 Vac, 60 Hz   | Environmental Conditions                 | 25°C, 75% RH                         |
| Tested by       | Perry Yang       |  |                                      |

| Phase Of Power : Line (L) |                 |                        |                      |       |                       |       |              |       |             |        |
|---------------------------|-----------------|------------------------|----------------------|-------|-----------------------|-------|--------------|-------|-------------|--------|
| No                        | Frequency (MHz) | Correction Factor (dB) | Reading Value (dBuV) |       | Emission Level (dBuV) |       | Limit (dBuV) |       | Margin (dB) |        |
|                           |                 |                        | Q.P.                 | AV.   | Q.P.                  | AV.   | Q.P.         | AV.   | Q.P.        | AV.    |
| 1                         | 0.15404         | 9.65                   | 38.11                | 31.16 | 47.76                 | 40.81 | 79.00        | 66.00 | -31.24      | -25.19 |
| 2                         | 0.22192         | 9.65                   | 36.78                | 24.02 | 46.43                 | 33.67 | 79.00        | 66.00 | -32.57      | -32.33 |
| 3                         | 1.57610         | 9.68                   | 32.93                | 26.83 | 42.61                 | 36.51 | 73.00        | 60.00 | -30.39      | -23.49 |
| 4                         | 2.21606         | 9.71                   | 27.47                | 21.01 | 37.18                 | 30.72 | 73.00        | 60.00 | -35.82      | -29.28 |
| 5                         | 4.11608         | 9.75                   | 26.04                | 19.94 | 35.79                 | 29.69 | 73.00        | 60.00 | -37.21      | -30.31 |
| 6                         | 13.10392        | 9.88                   | 28.33                | 20.50 | 38.21                 | 30.38 | 73.00        | 60.00 | -34.79      | -29.62 |

#### Remarks:

1. Q.P. and AV. are abbreviations of quasi-peak and average individually.
2. The emission levels of other frequencies were very low against the limit.
3. Margin value = Emission level – Limit value
4. Correction factor = Insertion loss + Cable loss
5. Emission Level = Correction Factor + Reading Value

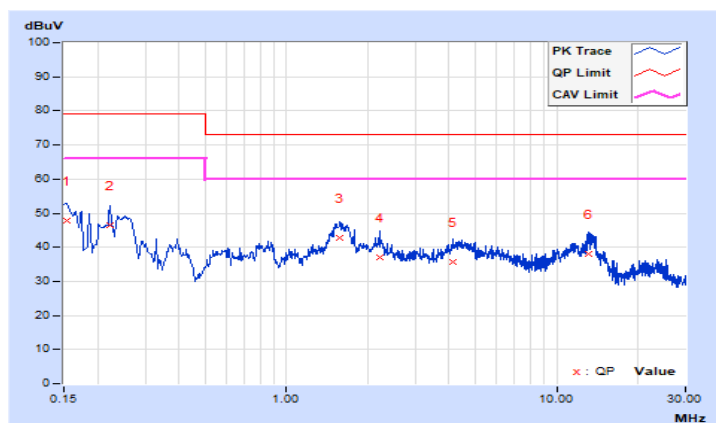

|                        |                  |   |                                      |
|------------------------|------------------|---|--------------------------------------|
| <b>Frequency Range</b> | 150 kHz ~ 30 MHz | <b>Detector Function &amp; Resolution Bandwidth</b> | Quasi-Peak (QP) / Average (AV), 9kHz |
| <b>Input Power</b>     | 110 Vac, 60 Hz   | <b>Environmental Conditions</b>                     | 25°C, 75% RH                         |
| <b>Tested by</b>       | Perry Yang       |   |                                      |

| Phase Of Power : Neutral (N) |                 |                        |                      |       |                       |       |              |       |             |        |
|------------------------------|-----------------|------------------------|----------------------|-------|-----------------------|-------|--------------|-------|-------------|--------|
| No                           | Frequency (MHz) | Correction Factor (dB) | Reading Value (dBuV) |       | Emission Level (dBuV) |       | Limit (dBuV) |       | Margin (dB) |        |
|                              |                 |                        | Q.P.                 | AV.   | Q.P.                  | AV.   | Q.P.         | AV.   | Q.P.        | AV.    |
| 1                            | 0.16208         | 9.65                   | 39.34                | 27.00 | 48.99                 | 36.65 | 79.00        | 66.00 | -30.01      | -29.35 |
| 2                            | 0.25806         | 9.65                   | 39.11                | 29.31 | 48.76                 | 38.96 | 79.00        | 66.00 | -30.24      | -27.04 |
| 3                            | 0.38212         | 9.65                   | 32.37                | 20.19 | 42.02                 | 29.84 | 79.00        | 66.00 | -36.98      | -36.16 |
| 4                            | 1.55196         | 9.69                   | 32.68                | 26.29 | 42.37                 | 35.98 | 73.00        | 60.00 | -30.63      | -24.02 |
| 5                            | 4.51206         | 9.77                   | 26.82                | 21.02 | 36.59                 | 30.79 | 73.00        | 60.00 | -36.41      | -29.21 |
| 6                            | 11.99992        | 9.92                   | 26.44                | 20.56 | 36.36                 | 30.48 | 73.00        | 60.00 | -36.64      | -29.52 |

**Remarks:**

1. Q.P. and AV. are abbreviations of quasi-peak and average individually.
2. The emission levels of other frequencies were very low against the limit.
3. Margin value = Emission level – Limit value
4. Correction factor = Insertion loss + Cable loss
5. Emission Level = Correction Factor + Reading Value

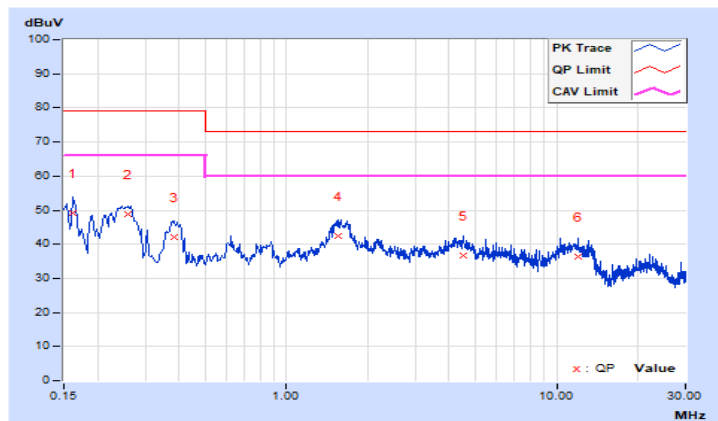

**Mode B**

|                        |                  |   |                                      |
|------------------------|------------------|---|--------------------------------------|
| <b>Frequency Range</b> | 150 kHz ~ 30 MHz | <b>Detector Function &amp; Resolution Bandwidth</b> | Quasi-Peak (QP) / Average (AV), 9kHz |
| <b>Input Power</b>     | 230 Vac, 50 Hz   | <b>Environmental Conditions</b>                     | 25°C, 75% RH                         |
| <b>Tested by</b>       | Perry Yang       |   |                                      |

| Phase Of Power : Line (L) |                 |                        |                      |              |                       |              |              |              |               |               |
|---------------------------|-----------------|------------------------|----------------------|--------------|-----------------------|--------------|--------------|--------------|---------------|---------------|
| No                        | Frequency (MHz) | Correction Factor (dB) | Reading Value (dBuV) |              | Emission Level (dBuV) |              | Limit (dBuV) |              | Margin (dB)   |               |
|                           |                 |                        | Q.P.                 | AV.          | Q.P.                  | AV.          | Q.P.         | AV.          | Q.P.          | AV.           |
| 1                         | 0.15406         | 9.65                   | 38.84                | 30.93        | 48.49                 | 40.58        | 79.00        | 66.00        | -30.51        | -25.42        |
| 2                         | 0.24558         | 9.65                   | 35.89                | 26.58        | 45.54                 | 36.23        | 79.00        | 66.00        | -33.46        | -29.77        |
| 3                         | 0.82061         | 9.66                   | 29.45                | 19.45        | 39.11                 | 29.11        | 73.00        | 60.00        | -33.89        | -30.89        |
| 4                         | 0.97208         | 9.66                   | 27.43                | 18.78        | 37.09                 | 28.44        | 73.00        | 60.00        | -35.91        | -31.56        |
| <b>5</b>                  | <b>1.61283</b>  | <b>9.68</b>            | <b>35.46</b>         | <b>27.81</b> | <b>45.14</b>          | <b>37.49</b> | <b>73.00</b> | <b>60.00</b> | <b>-27.86</b> | <b>-22.51</b> |
| 6                         | 4.56796         | 9.76                   | 27.95                | 21.36        | 37.71                 | 31.12        | 73.00        | 60.00        | -35.29        | -28.88        |

**Remarks:**

1. Q.P. and AV. are abbreviations of quasi-peak and average individually.
2. The emission levels of other frequencies were very low against the limit.
3. Margin value = Emission level – Limit value
4. Correction factor = Insertion loss + Cable loss
5. Emission Level = Correction Factor + Reading Value

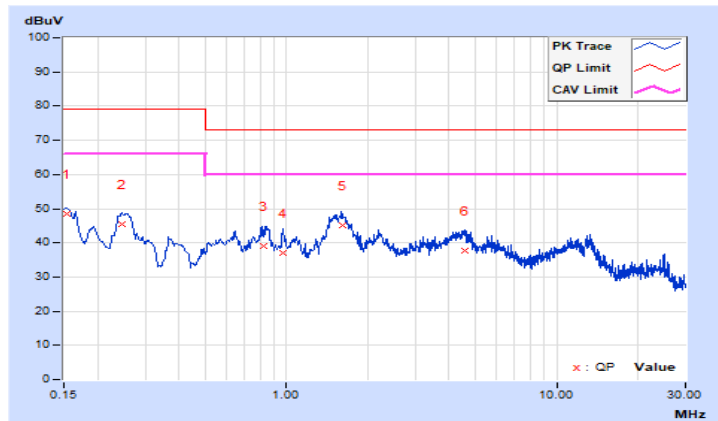

|                        |                  |   |                                      |
|------------------------|------------------|---|--------------------------------------|
| <b>Frequency Range</b> | 150 kHz ~ 30 MHz | <b>Detector Function &amp; Resolution Bandwidth</b> | Quasi-Peak (QP) / Average (AV), 9kHz |
| <b>Input Power</b>     | 230 Vac, 50 Hz   | <b>Environmental Conditions</b>                     | 25°C, 75% RH                         |
| <b>Tested by</b>       | Perry Yang       |   |                                      |

| Phase Of Power : Neutral (N) |                 |                        |                      |       |                       |       |              |       |             |        |
|------------------------------|-----------------|------------------------|----------------------|-------|-----------------------|-------|--------------|-------|-------------|--------|
| No                           | Frequency (MHz) | Correction Factor (dB) | Reading Value (dBuV) |       | Emission Level (dBuV) |       | Limit (dBuV) |       | Margin (dB) |        |
|                              |                 |                        | Q.P.                 | AV.   | Q.P.                  | AV.   | Q.P.         | AV.   | Q.P.        | AV.    |
| 1                            | 0.15002         | 9.65                   | 34.75                | 27.96 | 44.40                 | 37.61 | 79.00        | 66.00 | -34.60      | -28.39 |
| 2                            | 0.25338         | 9.65                   | 38.37                | 27.99 | 48.02                 | 37.64 | 79.00        | 66.00 | -30.98      | -28.36 |
| 3                            | 0.85990         | 9.67                   | 29.38                | 18.98 | 39.05                 | 28.65 | 73.00        | 60.00 | -33.95      | -31.35 |
| 4                            | 1.61245         | 9.69                   | 35.12                | 27.30 | 44.81                 | 36.99 | 73.00        | 60.00 | -28.19      | -23.01 |
| 5                            | 2.19610         | 9.71                   | 27.48                | 19.94 | 37.19                 | 29.65 | 73.00        | 60.00 | -35.81      | -30.35 |
| 6                            | 4.57019         | 9.77                   | 28.09                | 21.70 | 37.86                 | 31.47 | 73.00        | 60.00 | -35.14      | -28.53 |

**Remarks:**

1. Q.P. and AV. are abbreviations of quasi-peak and average individually.
2. The emission levels of other frequencies were very low against the limit.
3. Margin value = Emission level – Limit value
4. Correction factor = Insertion loss + Cable loss
5. Emission Level = Correction Factor + Reading Value

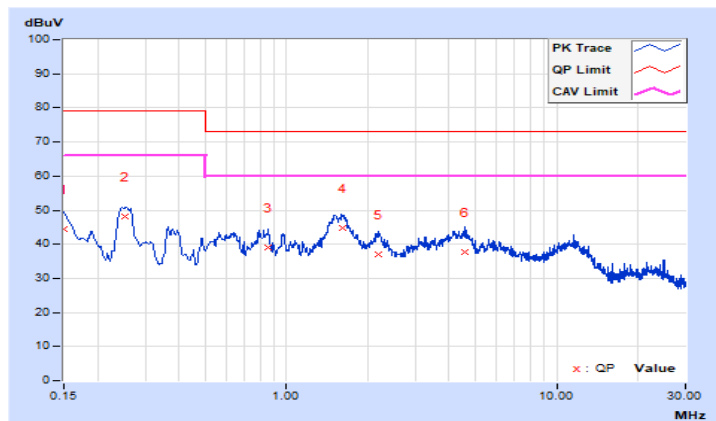

## 7.2 Conducted Emissions from Wired Network Ports

### Mode A

|                 |                  |  |                                      |
|-----------------|------------------|--|--------------------------------------|
| Frequency Range | 150 kHz ~ 30 MHz | Detector Function & Resolution Bandwidth | Quasi-Peak (QP) / Average (AV), 9kHz |
| Input Power     | 230 Vac, 50 Hz   | Environmental Conditions                 | 25°C, 75% RH                         |
| Tested by       | Perry Yang       |  |                                      |

| No | Frequency (MHz) | Correction Factor (dB) | Reading Value (dBuV) |       | Emission Level (dBuV) |       | Limit (dBuV) |       | Margin (dB) |        |
|----|-----------------|------------------------|----------------------|-------|-----------------------|-------|--------------|-------|-------------|--------|
|    |                 |                        | Q.P.                 | AV.   | Q.P.                  | AV.   | Q.P.         | AV.   | Q.P.        | AV.    |
| 1  | 0.35507         | 9.74                   | 43.38                | 33.76 | 53.12                 | 43.50 | 89.84        | 76.84 | -36.72      | -33.34 |
| 2  | 0.70334         | 9.72                   | 44.34                | 35.64 | 54.06                 | 45.36 | 87.00        | 74.00 | -32.94      | -28.64 |
| 3  | 0.96646         | 9.70                   | 42.84                | 34.74 | 52.54                 | 44.44 | 87.00        | 74.00 | -34.46      | -29.56 |
| 4  | 1.55957         | 9.73                   | 42.33                | 35.65 | 52.06                 | 45.38 | 87.00        | 74.00 | -34.94      | -28.62 |
| 5  | 1.88003         | 9.75                   | 41.47                | 34.14 | 51.22                 | 43.89 | 87.00        | 74.00 | -35.78      | -30.11 |
| 6  | 4.63592         | 9.85                   | 42.26                | 36.97 | 52.11                 | 46.82 | 87.00        | 74.00 | -34.89      | -27.18 |

### Remarks:

1. Q.P. and AV. are abbreviations of quasi-peak and average individually.
2. The emission levels of other frequencies were very low against the limit.
3. Margin value = Emission level – Limit value
4. Correction factor = Insertion loss + Cable loss
5. Emission Level = Correction Factor + Reading Value

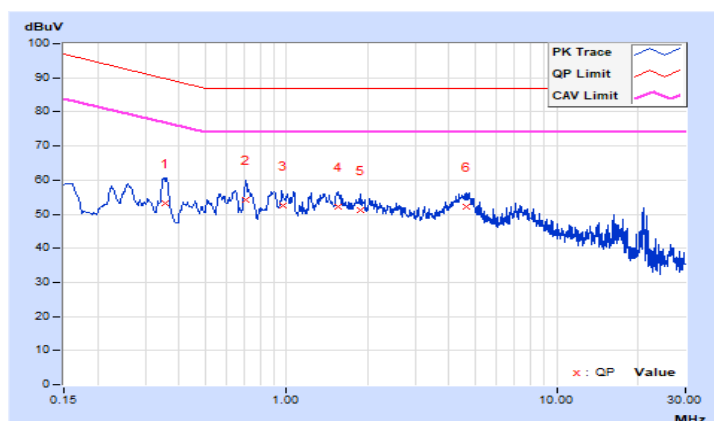

### Mode B

|                        |                  |   |                                      |
|------------------------|------------------|---|--------------------------------------|
| <b>Frequency Range</b> | 150 kHz ~ 30 MHz | <b>Detector Function &amp; Resolution Bandwidth</b> | Quasi-Peak (QP) / Average (AV), 9kHz |
| <b>Input Power</b>     | 230 Vac, 50 Hz   | <b>Environmental Conditions</b>                     | 25°C, 75% RH                         |
| <b>Tested by</b>       | Perry Yang       |   |                                      |

| No | Frequency (MHz) | Correction Factor (dB) | Reading Value (dBuV) |       | Emission Level (dBuV) |       | Limit (dBuV) |       | Margin (dB) |        |
|----|-----------------|------------------------|----------------------|-------|-----------------------|-------|--------------|-------|-------------|--------|
|    |                 |                        | Q.P.                 | AV.   | Q.P.                  | AV.   | Q.P.         | AV.   | Q.P.        | AV.    |
| 1  | 0.40200         | 9.74                   | 47.22                | 40.73 | 56.96                 | 50.47 | 88.81        | 75.81 | -31.85      | -25.34 |
| 2  | 0.71686         | 9.72                   | 43.95                | 36.78 | 53.67                 | 46.50 | 87.00        | 74.00 | -33.33      | -27.50 |
| 3  | 0.82178         | 9.71                   | 44.77                | 35.79 | 54.48                 | 45.50 | 87.00        | 74.00 | -32.52      | -28.50 |
| 4  | 3.21542         | 9.80                   | 37.67                | 29.17 | 47.47                 | 38.97 | 87.00        | 74.00 | -39.53      | -35.03 |
| 5  | 4.64386         | 9.85                   | 41.46                | 35.65 | 51.31                 | 45.50 | 87.00        | 74.00 | -35.69      | -28.50 |
| 6  | 16.07855        | 10.29                  | 39.26                | 24.78 | 49.55                 | 35.07 | 87.00        | 74.00 | -37.45      | -38.93 |

#### Remarks:

1. Q.P. and AV. are abbreviations of quasi-peak and average individually.
2. The emission levels of other frequencies were very low against the limit.
3. Margin value = Emission level – Limit value
4. Correction factor = Insertion loss + Cable loss
5. Emission Level = Correction Factor + Reading Value

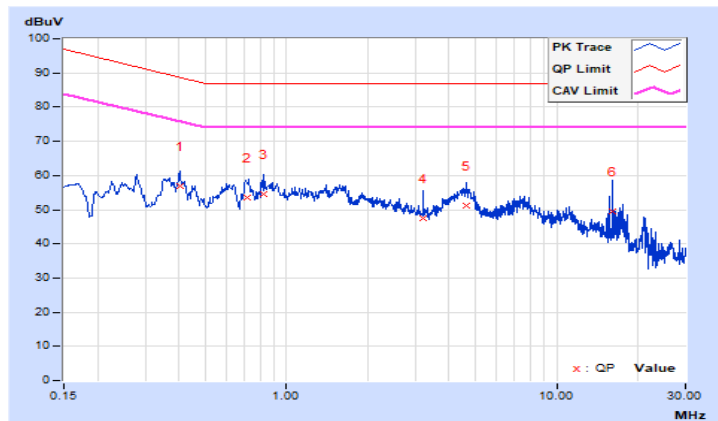

### Mode C

|                        |                  |   |                                      |
|------------------------|------------------|---|--------------------------------------|
| <b>Frequency Range</b> | 150 kHz ~ 30 MHz | <b>Detector Function &amp; Resolution Bandwidth</b> | Quasi-Peak (QP) / Average (AV), 9kHz |
| <b>Input Power</b>     | 230 Vac, 50 Hz   | <b>Environmental Conditions</b>                     | 25°C, 75% RH                         |
| <b>Tested by</b>       | Perry Yang       |   |                                      |

| No       | Frequency (MHz) | Correction Factor (dB) | Reading Value (dBuV) |              | Emission Level (dBuV) |              | Limit (dBuV) |              | Margin (dB)   |               |
|----------|-----------------|------------------------|----------------------|--------------|-----------------------|--------------|--------------|--------------|---------------|---------------|
|          |                 |                        | Q.P.                 | AV.          | Q.P.                  | AV.          | Q.P.         | AV.          | Q.P.          | AV.           |
| 1        | 0.39402         | 9.74                   | 44.34                | 40.14        | 54.08                 | 49.88        | 88.98        | 75.98        | -34.90        | -26.10        |
| 2        | 1.61202         | 9.73                   | 37.91                | 30.32        | 47.64                 | 40.05        | 87.00        | 74.00        | -39.36        | -33.95        |
| 3        | 3.21108         | 9.80                   | 43.75                | 29.29        | 53.55                 | 39.09        | 87.00        | 74.00        | -33.45        | -34.91        |
| 4        | 4.55196         | 9.84                   | 37.10                | 31.26        | 46.94                 | 41.10        | 87.00        | 74.00        | -40.06        | -32.90        |
| 5        | 13.38130        | 10.16                  | 40.85                | 39.01        | 51.01                 | 49.17        | 87.00        | 74.00        | -35.99        | -24.83        |
| <b>6</b> | <b>17.69417</b> | <b>10.37</b>           | <b>45.18</b>         | <b>41.50</b> | <b>55.55</b>          | <b>51.87</b> | <b>87.00</b> | <b>74.00</b> | <b>-31.45</b> | <b>-22.13</b> |

#### Remarks:

1. Q.P. and AV. are abbreviations of quasi-peak and average individually.
2. The emission levels of other frequencies were very low against the limit.
3. Margin value = Emission level – Limit value
4. Correction factor = Insertion loss + Cable loss
5. Emission Level = Correction Factor + Reading Value

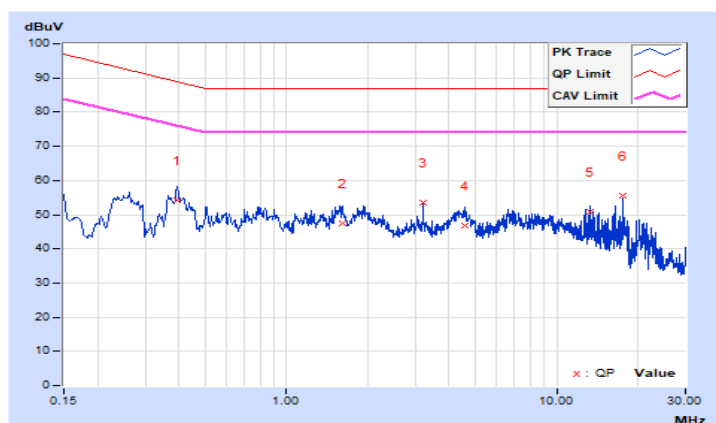



### 7.3 Radiated Emissions up to 1 GHz

#### Mode A

|                 |                |  |                          |
|-----------------|----------------|--|--------------------------|
| Frequency Range | 30 MHz ~ 1 GHz | Detector Function & Resolution Bandwidth | Quasi-Peak (QP), 120 kHz |
| Input Power     | 230 Vac, 50 Hz | Environmental Conditions                 | 26°C, 68% RH             |
| Tested By       | Paul Chen      |  |                          |

| Antenna Polarity & Test Distance : Horizontal at 10 m |                 |                         |                |             |                    |                      |                  |                          |
|---|-----------------|-------------------------|----------------|-------------|--------------------|----------------------|------------------|--------------------------|
| No  | Frequency (MHz) | Emission Level (dBuV/m) | Limit (dBuV/m) | Margin (dB) | Antenna Height (m) | Table Angle (Degree) | Raw Value (dBuV) | Correction Factor (dB/m) |
| 1   | 73.81           | 33.82 QP                | 40.00          | -6.18       | 4.00 H             | 111                  | 45.49            | -11.67                   |
| 2   | 125.02          | 31.19 QP                | 40.00          | -8.81       | 4.00 H             | 230                  | 41.01            | -9.82                    |
| 3   | 153.43          | 30.09 QP                | 40.00          | -9.91       | 4.00 H             | 120                  | 37.91            | -7.82                    |
| 4   | 200.01          | 30.87 QP                | 40.00          | -9.13       | 4.00 H             | 163                  | 41.62            | -10.75                   |
| 5   | 222.28          | 26.27 QP                | 40.00          | -13.73      | 4.00 H             | 196                  | 36.70            | -10.43                   |
| 6   | 250.01          | 37.55 QP                | 47.00          | -9.45       | 3.81 H             | 29                   | 45.65            | -8.10                    |
| 7   | 325.02          | 39.63 QP                | 47.00          | -7.37       | 3.19 H             | 111                  | 44.94            | -5.31                    |
| 8   | 462.02          | 41.99 QP                | 47.00          | -5.01       | 2.14 H             | 335                  | 44.16            | -2.17                    |
| 9   | 499.99          | 38.82 QP                | 47.00          | -8.18       | 1.86 H             | 225                  | 40.51            | -1.69                    |
| 10  | 547.51          | 46.15 QP                | 47.00          | -0.85       | 1.92 H             | 122                  | 46.83            | -0.68                    |
| 11  | 616.00          | 43.28 QP                | 47.00          | -3.72       | 1.39 H             | 222                  | 41.74            | 1.54                     |
| 12  | 662.49          | 46.37 QP                | 47.00          | -0.63       | 1.28 H             | 199                  | 43.49            | 2.88                     |
| 13  | 924.01          | 37.86 QP                | 47.00          | -9.14       | 1.00 H             | 160                  | 29.39            | 8.47                     |
| 14  | 999.98          | 42.27 QP                | 47.00          | -4.73       | 1.00 H             | 150                  | 32.78            | 9.49                     |

#### Remarks:

1. Emission Level(dBuV/m) = Raw Value(dBuV) + Correction Factor(dB/m)
2. Correction Factor(dB/m) = Antenna Factor (dB/m) + Cable Factor (dB)  
– Pre-Amplifier Factor (dB)
3. The other emission levels were very low against the limit.
4. Margin value = Emission level – Limit value

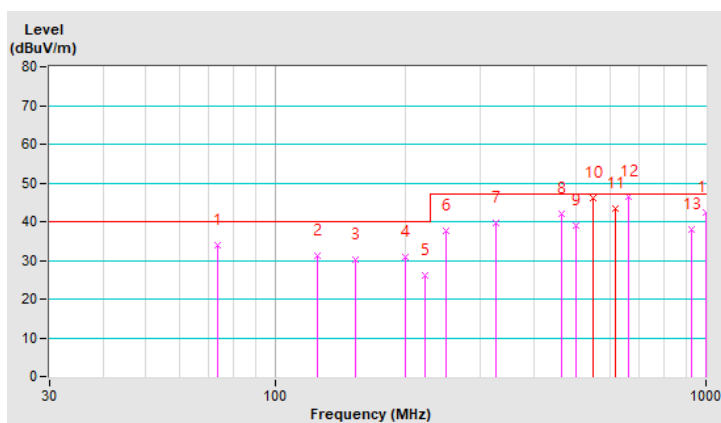

|                 |                |  |                          |
|-----------------|----------------|--|--------------------------|
| Frequency Range | 30 MHz ~ 1 GHz | Detector Function & Resolution Bandwidth | Quasi-Peak (QP), 120 kHz |
| Input Power     | 230 Vac, 50 Hz | Environmental Conditions                 | 26°C, 68% RH             |
| Tested By       | Paul Chen      |  |                          |

| Antenna Polarity & Test Distance : Vertical at 10 m |                 |                         |                |             |                    |                      |                  |                          |
|---|-----------------|-------------------------|----------------|-------------|--------------------|----------------------|------------------|--------------------------|
| No  | Frequency (MHz) | Emission Level (dBuV/m) | Limit (dBuV/m) | Margin (dB) | Antenna Height (m) | Table Angle (Degree) | Raw Value (dBuV) | Correction Factor (dB/m) |
| 1   | 75.86           | 35.22 QP                | 40.00          | -4.78       | 1.55 V             | 29                   | 47.41            | -12.19                   |
| 2   | 85.49           | 34.29 QP                | 40.00          | -5.71       | 1.83 V             | 225                  | 48.50            | -14.21                   |
| 3   | 115.51          | 31.21 QP                | 40.00          | -8.79       | 1.00 V             | 182                  | 41.98            | -10.77                   |
| 4   | 124.99          | 35.89 QP                | 40.00          | -4.11       | 1.00 V             | 260                  | 45.73            | -9.84                    |
| 5   | 198.01          | 35.21 QP                | 40.00          | -4.79       | 1.00 V             | 258                  | 45.97            | -10.76                   |
| 6   | 222.34          | 34.27 QP                | 40.00          | -5.73       | 1.00 V             | 317                  | 44.70            | -10.43                   |
| 7   | 249.99          | 35.19 QP                | 47.00          | -11.81      | 1.00 V             | 196                  | 43.29            | -8.10                    |
| 8   | 308.02          | 37.39 QP                | 47.00          | -9.61       | 1.00 V             | 242                  | 43.19            | -5.80                    |
| 9   | 462.01          | 45.39 QP                | 47.00          | -1.61       | 1.00 V             | 196                  | 47.56            | -2.17                    |
| 10  | 499.99          | 37.29 QP                | 47.00          | -9.71       | 1.00 V             | 273                  | 38.98            | -1.69                    |
| 11  | 547.49          | 41.32 QP                | 47.00          | -5.68       | 3.56 V             | 258                  | 42.02            | -0.70                    |
| 12  | 616.02          | 44.24 QP                | 47.00          | -2.76       | 3.28 V             | 286                  | 42.70            | 1.54                     |
| 13  | 924.00          | 40.01 QP                | 47.00          | -6.99       | 2.13 V             | 155                  | 31.54            | 8.47                     |
| 14  | 999.98          | 38.86 QP                | 47.00          | -8.14       | 2.04 V             | 25                   | 29.37            | 9.49                     |

**Remarks:**

1. Emission Level(dBuV/m) = Raw Value(dBuV) + Correction Factor(dB/m)
2. Correction Factor(dB/m) = Antenna Factor (dB/m) + Cable Factor (dB)  
– Pre-Amplifier Factor (dB)
3. The other emission levels were very low against the limit.
4. Margin value = Emission level – Limit value

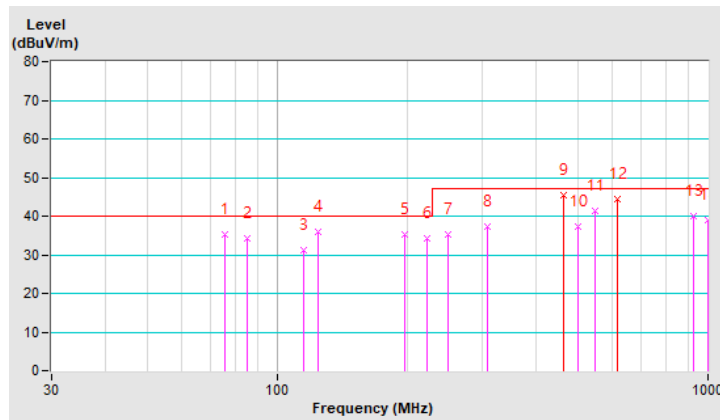

## 7.4 Radiated Emissions above 1 GHz

### Mode A

|                        |                |   |                                |
|------------------------|----------------|---|--------------------------------|
| <b>Frequency Range</b> | 1 GHz ~ 6 GHz  | <b>Detector Function &amp; Resolution Bandwidth</b> | Peak (PK) / Average (AV), 1MHz |
| <b>Input Power</b>     | 230 Vac, 50 Hz | <b>Environmental Conditions</b>                     | 20°C, 70% RH                   |
| <b>Tested By</b>       | Bob Lin        |   |                                |

| Antenna Polarity & Test Distance : Horizontal at 3 m |                 |                         |                |             |                    |                      |                  |                          |
|--|-----------------|-------------------------|----------------|-------------|--------------------|----------------------|------------------|--------------------------|
| No   | Frequency (MHz) | Emission Level (dBuV/m) | Limit (dBuV/m) | Margin (dB) | Antenna Height (m) | Table Angle (Degree) | Raw Value (dBuV) | Correction Factor (dB/m) |
| 1  | 1539.94         | 55.43 PK                | 76.00          | -20.57      | 1.54 H             | 286                  | 58.57            | -3.14                    |
| 2  | 1539.94         | 45.60 AV                | 56.00          | -10.40      | 1.54 H             | 286                  | 48.74            | -3.14                    |
| 3  | 1903.78         | 55.15 PK                | 76.00          | -20.85      | 1.42 H             | 236                  | 56.94            | -1.79                    |
| 4  | 1903.78         | 41.10 AV                | 56.00          | -14.90      | 1.42 H             | 236                  | 42.89            | -1.79                    |
| 5  | 2002.00         | 54.35 PK                | 76.00          | -21.65      | 1.00 H             | 85                   | 55.72            | -1.37                    |
| 6  | 2002.00         | 48.26 AV                | 56.00          | -7.74       | 1.00 H             | 85                   | 49.63            | -1.37                    |
| 7  | 2310.01         | 57.08 PK                | 76.00          | -18.92      | 2.35 H             | 275                  | 57.56            | -0.48                    |
| 8  | 2310.01         | 40.01 AV                | 56.00          | -15.99      | 2.35 H             | 275                  | 40.49            | -0.48                    |
| 9  | 2463.94         | 56.18 PK                | 76.00          | -19.82      | 2.50 H             | 89                   | 56.23            | -0.05                    |
| 10   | 2463.94         | 42.19 AV                | 56.00          | -13.81      | 2.50 H             | 89                   | 42.24            | -0.05                    |
| 11   | 3849.96         | 58.88 PK                | 80.00          | -21.12      | 1.60 H             | 126                  | 53.44            | 5.44                     |
| 12   | 3849.96         | 44.17 AV                | 60.00          | -15.83      | 1.60 H             | 126                  | 38.73            | 5.44                     |
| 13   | 4003.98         | 58.44 PK                | 80.00          | -21.56      | 1.42 H             | 104                  | 52.84            | 5.60                     |
| 14   | 4003.98         | 44.25 AV                | 60.00          | -15.75      | 1.42 H             | 104                  | 38.65            | 5.60                     |

#### Remarks:

1. Emission Level(dBuV/m) = Raw Value(dBuV) + Correction Factor(dB/m)
2. Correction Factor(dB/m) = Antenna Factor (dB/m) + Cable Factor (dB)  
– Pre-Amplifier Factor (dB)
3. The other emission levels were very low against the limit.
4. Margin value = Emission level – Limit value

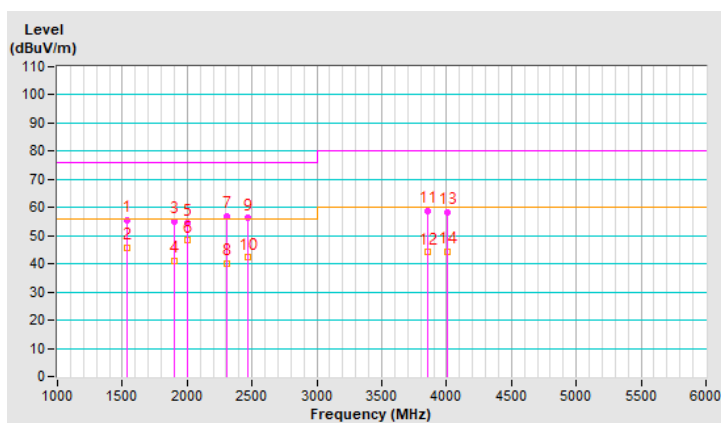

|                 |                |  |                                |
|-----------------|----------------|--|--------------------------------|
| Frequency Range | 1 GHz ~ 6 GHz  | Detector Function & Resolution Bandwidth | Peak (PK) / Average (AV), 1MHz |
| Input Power     | 230 Vac, 50 Hz | Environmental Conditions                 | 20°C, 70% RH                   |
| Tested By       | Bob Lin        |  |                                |

| Antenna Polarity & Test Distance : Vertical at 3 m |                 |                         |                |              |                    |                      |                  |                          |
|--|-----------------|-------------------------|----------------|--------------|--------------------|----------------------|------------------|--------------------------|
| No   | Frequency (MHz) | Emission Level (dBuV/m) | Limit (dBuV/m) | Margin (dB)  | Antenna Height (m) | Table Angle (Degree) | Raw Value (dBuV) | Correction Factor (dB/m) |
| 1  | 1540.01         | 60.87 PK                | 76.00          | -15.13       | 1.96 V             | 131                  | 64.01            | -3.14                    |
| 2  | <b>1540.01</b>  | <b>50.49 AV</b>         | <b>56.00</b>   | <b>-5.51</b> | <b>1.96 V</b>      | <b>131</b>           | <b>53.63</b>     | <b>-3.14</b>             |
| 3  | 1878.75         | 54.94 PK                | 76.00          | -21.06       | 1.00 V             | 235                  | 56.75            | -1.81                    |
| 4  | 1878.75         | 38.58 AV                | 56.00          | -17.42       | 1.00 V             | 235                  | 40.39            | -1.81                    |
| 5  | 2155.98         | 53.74 PK                | 76.00          | -22.26       | 1.64 V             | 164                  | 54.91            | -1.17                    |
| 6  | 2155.98         | 40.53 AV                | 56.00          | -15.47       | 1.64 V             | 164                  | 41.70            | -1.17                    |
| 7  | 2309.99         | 57.18 PK                | 76.00          | -18.82       | 1.04 V             | 221                  | 57.66            | -0.48                    |
| 8  | 2309.99         | 42.72 AV                | 56.00          | -13.28       | 1.04 V             | 221                  | 43.20            | -0.48                    |
| 9  | 3695.96         | 59.21 PK                | 80.00          | -20.79       | 2.10 V             | 71                   | 54.25            | 4.96                     |
| 10   | 3695.96         | 44.62 AV                | 60.00          | -15.38       | 2.10 V             | 71                   | 39.66            | 4.96                     |
| 11   | 3849.99         | 61.57 PK                | 80.00          | -18.43       | 1.39 V             | 189                  | 56.13            | 5.44                     |
| 12   | 3849.99         | 45.15 AV                | 60.00          | -14.85       | 1.39 V             | 189                  | 39.71            | 5.44                     |
| 13   | 4003.96         | 58.77 PK                | 80.00          | -21.23       | 1.89 V             | 220                  | 53.17            | 5.60                     |
| 14   | 4003.96         | 45.39 AV                | 60.00          | -14.61       | 1.89 V             | 220                  | 39.79            | 5.60                     |
| 15   | 4986.45         | 54.77 PK                | 80.00          | -25.23       | 1.34 V             | 16                   | 47.52            | 7.25                     |
| 16   | 4986.45         | 37.88 AV                | 60.00          | -22.12       | 1.34 V             | 16                   | 30.63            | 7.25                     |

**Remarks:**

1. Emission Level(dBuV/m) = Raw Value(dBuV) + Correction Factor(dB/m)
2. Correction Factor(dB/m) = Antenna Factor (dB/m) + Cable Factor (dB) – Pre-Amplifier Factor (dB)
3. The other emission levels were very low against the limit.
4. Margin value = Emission level – Limit value

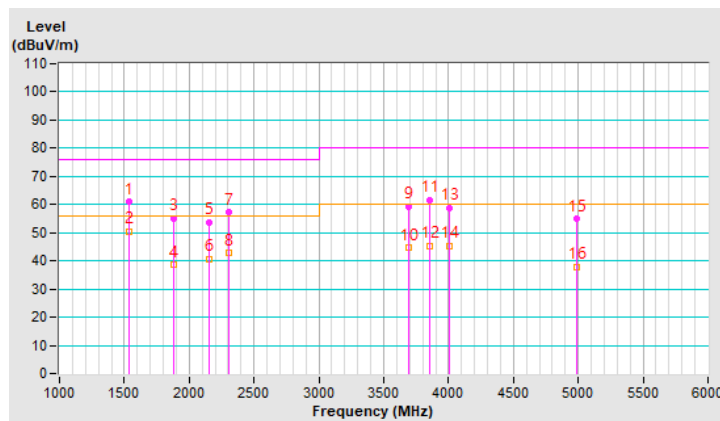



### 7.5 Harmonic Current Measurement

#### Mode A

|                          |          |                                     |                          |
|--------------------------|----------|-------------------------------------|--------------------------|
| <b>Test Duration</b>     | 5 min    | <b>Fundamental Voltage / Ampere</b> | 230.18 Vrms / 0.497 Arms |
| <b>Power Consumption</b> | 101.1 W  | <b>Power Frequency</b>              | 50 Hz                    |
| <b>Power Factor</b>      | 0.905    | <b>Environmental Conditions</b>     | 24°C, 72% RH             |
| <b>Tested By</b>         | Joey Liu |                                     |                          |

| Harm# | Harms (avg) (A) | 100% Limit (A) | Harms (max) (A) | 150% Limit (A) |
|-------|-----------------|----------------|-----------------|----------------|
| 1     | 0.454           | -              | 1.107           | -              |
| 2     | 0.004           | 1.080          | 0.005           | 1.620          |
| 3     | 0.150           | 2.300          | 0.161           | 3.450          |
| 4     | 0.002           | 0.430          | 0.004           | 0.645          |
| 5     | 0.046           | 1.140          | 0.049           | 1.710          |
| 6     | 0.002           | 0.300          | 0.003           | 0.450          |
| 7     | 0.020           | 0.770          | 0.023           | 1.155          |
| 8     | 0.002           | 0.230          | 0.002           | 0.345          |
| 9     | 0.009           | 0.400          | 0.010           | 0.600          |
| 10    | 0.001           | 0.184          | 0.002           | 0.276          |
| 11    | 0.010           | 0.330          | 0.011           | 0.495          |
| 12    | 0.001           | 0.153          | 0.002           | 0.230          |
| 13    | 0.009           | 0.210          | 0.010           | 0.315          |
| 14    | 0.001           | 0.131          | 0.002           | 0.197          |
| 15    | 0.006           | 0.150          | 0.007           | 0.225          |
| 16    | 0.001           | 0.115          | 0.002           | 0.173          |
| 17    | 0.005           | 0.132          | 0.007           | 0.198          |
| 18    | 0.001           | 0.102          | 0.002           | 0.153          |
| 19    | 0.008           | 0.118          | 0.009           | 0.178          |
| 20    | 0.002           | 0.092          | 0.002           | 0.138          |
| 21    | 0.004           | 0.107          | 0.008           | 0.161          |
| 22    | 0.002           | 0.084          | 0.002           | 0.125          |
| 23    | 0.005           | 0.098          | 0.006           | 0.147          |
| 24    | 0.001           | 0.077          | 0.002           | 0.115          |
| 25    | 0.005           | 0.090          | 0.005           | 0.135          |
| 26    | 0.001           | 0.071          | 0.002           | 0.107          |
| 27    | 0.004           | 0.083          | 0.006           | 0.125          |
| 28    | 0.001           | 0.066          | 0.002           | 0.099          |
| 29    | 0.004           | 0.078          | 0.006           | 0.116          |
| 30    | 0.001           | 0.061          | 0.002           | 0.092          |
| 31    | 0.007           | 0.073          | 0.010           | 0.109          |
| 32    | 0.001           | 0.058          | 0.002           | 0.086          |
| 33    | 0.005           | 0.068          | 0.006           | 0.102          |
| 34    | 0.001           | 0.054          | 0.002           | 0.081          |
| 35    | 0.004           | 0.064          | 0.005           | 0.096          |
| 36    | 0.001           | 0.051          | 0.002           | 0.077          |
| 37    | 0.004           | 0.061          | 0.006           | 0.091          |
| 38    | 0.001           | 0.048          | 0.002           | 0.073          |
| 39    | 0.006           | 0.058          | 0.008           | 0.087          |
| 40    | 0.001           | 0.046          | 0.001           | 0.069          |

Note: Dynamic limits were applied for this test. The highest harmonics values in the above table may not occur at the same window as the maximum harmonics/limit ratio.

## 7.6 Voltage Fluctuations and Flicker Measurement

### Mode A

|                         |                |                                 |              |
|-------------------------|----------------|---------------------------------|--------------|
| <b>Observation (Tp)</b> | 10 min         |                                 |              |
| <b>Input Power</b>      | 230 Vac, 50 Hz | <b>Environmental Conditions</b> | 24°C, 72% RH |
| <b>Tested By</b>        | Joey Liu       |                                 |              |

| Test Parameter | Measurement Value | Limit | Remarks |
|----------------|-------------------|-------|---------|
| $P_{st}$       | 0.263             | 1.00  | Pass    |
| $P_{lt}$       | 0.115             | 0.65  | Pass    |
| $T_{max}$ (ms) | 0.000             | 500   | Pass    |
| $d_{max}$ (%)  | 0.000             | 4.00  | Pass    |
| $d_c$ (%)      | 0.000             | 3.30  | Pass    |

#### Notes:

1.  $P_{st}$  means short-term flicker indicator.
2.  $P_{lt}$  means long-term flicker indicator.
3.  $T_{max}$  means accumulated time value of  $d(t)$  with a deviation exceeding 3.3 %.
4.  $d_{max}$  means maximum relative voltage change.
5.  $d_c$  means maximum relative steady-state voltage change.

## 7.7 Electrostatic Discharges (ESD)

### Mode A

#### For EN 55035

|             |                |                          |                             |
|-------------|----------------|--------------------------|-----------------------------|
| Input Power | AC 230V / 50Hz | Environmental conditions | 24 °C, 43 % RH<br>1007 mbar |
| Tested by   | Chiming Li     |                          |                             |

#### Test Results of Direct Application

| Discharge Level (kV) | Polarity (+/-) | Test Point        | Contact Discharge | Air Discharge | Performance Criteria |
|----------------------|----------------|-------------------|-------------------|---------------|----------------------|
| 2,4                  | +/-            | 1-4,8-12,18,19,20 | Note 1            | ---           | A                    |
| 2,4                  | +/-            | 5,6,7,13-17,21    | ---               | Note 1        | A                    |
| 8                    | +/-            | 5,6,13-17,21      | ---               | Note 1        | A                    |
| 8                    | +/-            | 7                 | ---               | Note 2        | B                    |

Description of test points of direct application: Please refer to following page for representative mark only.

#### Test Results of Indirect Application

| Discharge Level (kV) | Polarity (+/-) | Test Point | Horizontal Coupling Plane | Vertical Coupling Plane | Performance Criteria |
|----------------------|----------------|------------|---------------------------|-------------------------|----------------------|
| 2,4                  | +/-            | Four Side  | Note 1                    | Note 1                  | A                    |

Description of test points of indirect application:

1. Front side
2. Rear side
3. Right side
4. Left side

Please refer to the attached page for description of test points.

Notes:

1. The EUT is operated normal during the test.
2. The output monitor's screen have flicker during the test, but self-recoverable after the test.

#### Description of test point

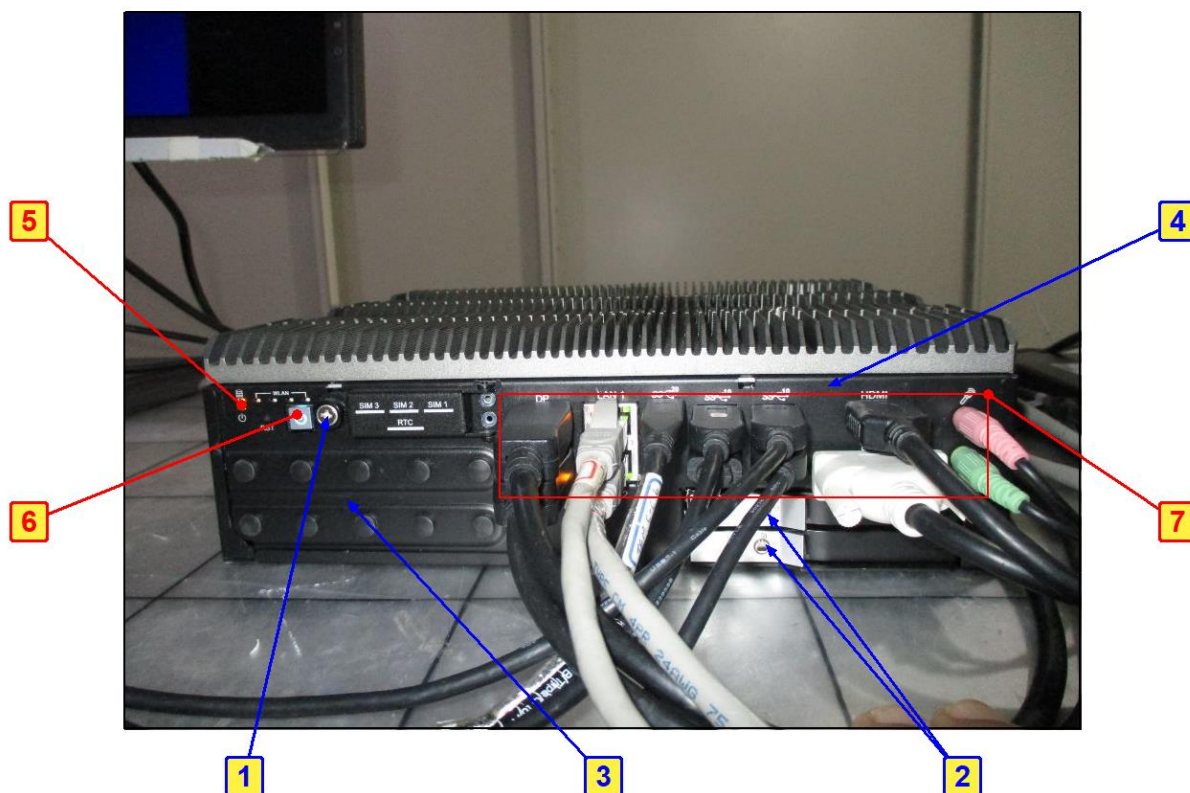

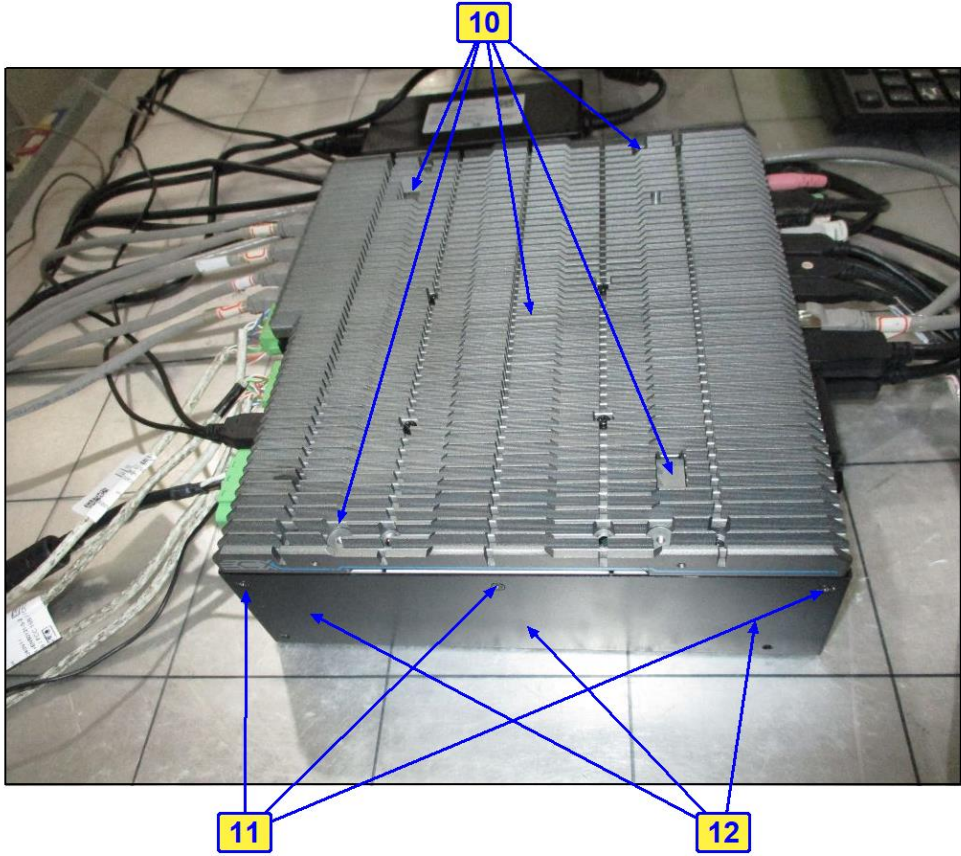
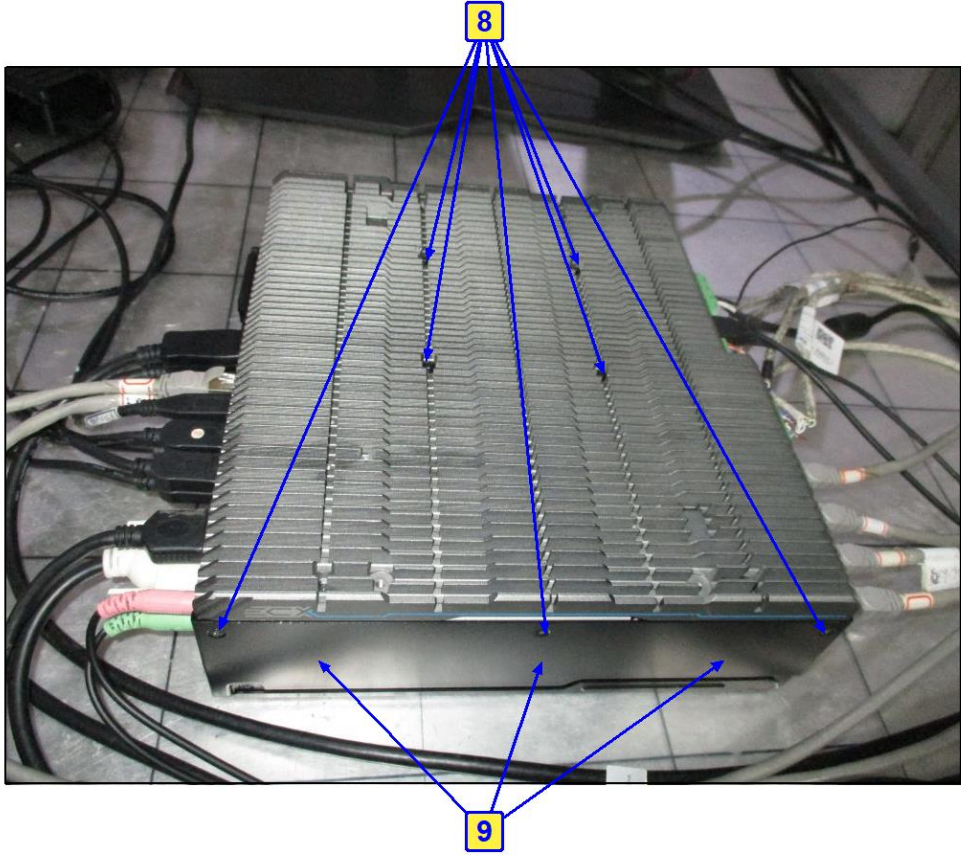



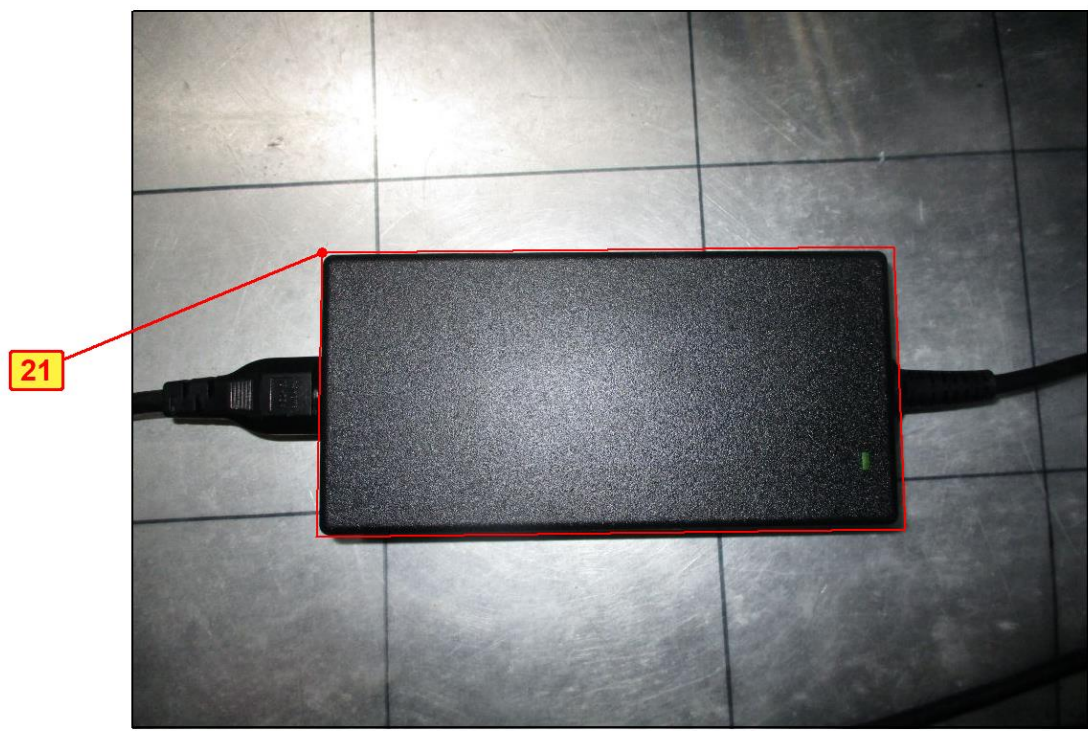
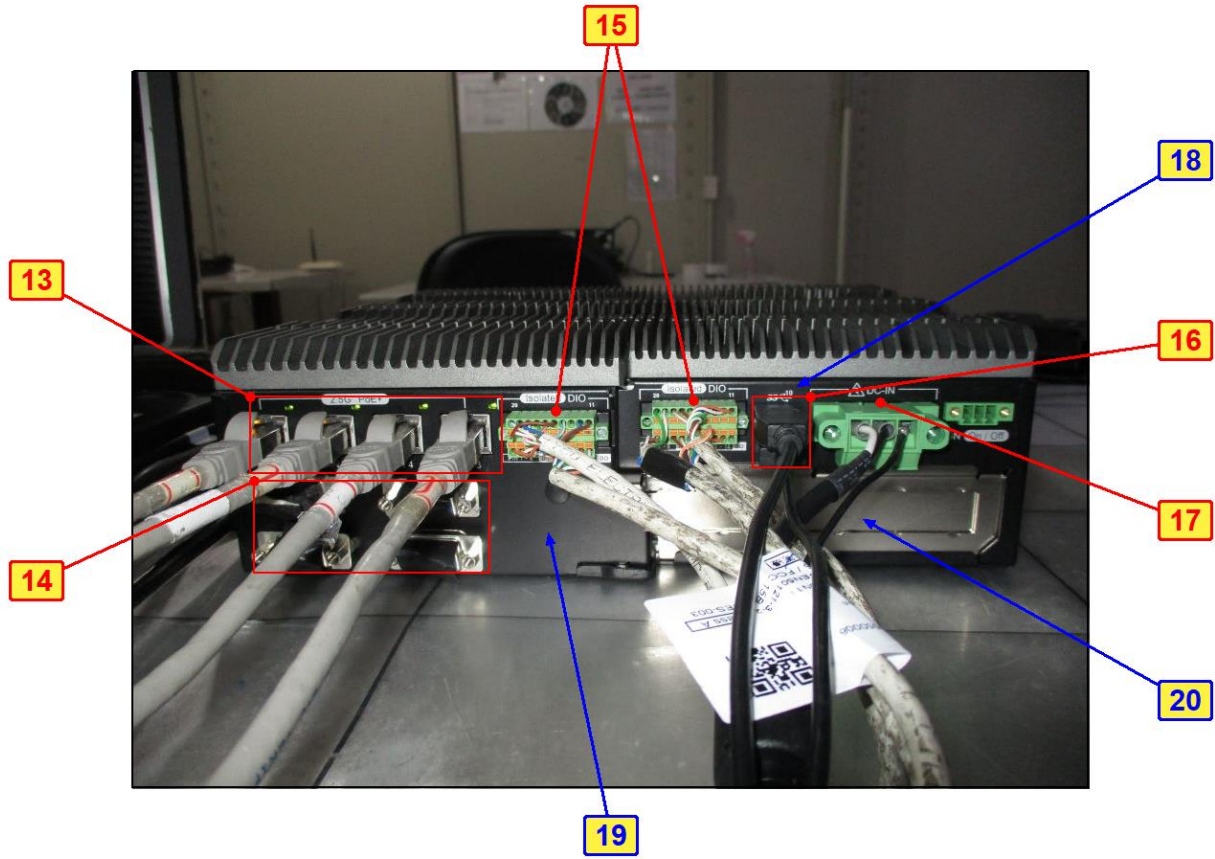

## 7.8 Radio Frequency Electromagnetic Field (RS)

### Mode A

#### For EN 55035

|             |                |                          |                             |
|-------------|----------------|--------------------------|-----------------------------|
| Input Power | AC 230V / 50Hz | Environmental conditions | 22 °C, 71 % RH<br>1006 mbar |
| Tested by   | Joey Liu       |                          |                             |

| Frequency (MHz)        | Polarity | Azimuth(°)      | Applied Field Strength |               | Observation | Performance Criteria |
|------------------------|----------|-----------------|------------------------|---------------|-------------|----------------------|
|                        |          |                 | (V/m)                  | Modulation    |             |                      |
| 80 - 1000              | V&H      | 0, 90, 180, 270 | 3                      | 80% AM (1kHz) | Note 1      | A                    |
| 1800, 2600, 3500, 5000 | V&H      | 0, 90, 180, 270 | 3                      | 80% AM (1kHz) | Note 1      | A                    |
| 80 - 1000              | V&H      | 0, 90, 180, 270 | 3                      | 80% AM (1kHz) | Note 2      | A                    |
| 1800, 2600, 3500, 5000 | V&H      | 0, 90, 180, 270 | 3                      | 80% AM (1kHz) | Note 2      | A                    |

#### Notes:

1. The EUT is operated normal during the test.
2. Audio Out Function (Headset out) Electrical Reference level Pass.

## 7.9 Fast Transients Common Mode (EFT)

### Mode A

#### For EN 55035

|             |                |                          |                             |
|-------------|----------------|--------------------------|-----------------------------|
| Input Power | AC 230V / 50Hz | Environmental conditions | 25 °C, 71 % RH<br>1008 mbar |
| Tested by   | Chiming Li     |                          |                             |

| Input AC power port |            |                |             |                      |
|---------------------|------------|----------------|-------------|----------------------|
| Voltage (kV)        | Test Point | Polarity (+/-) | Observation | Performance Criteria |
| 1                   | L          | +/-            | Note        | A                    |
| 1                   | N          | +/-            | Note        | A                    |
| 1                   | PE         | +/-            | Note        | A                    |
| 1                   | L-N-PE     | +/-            | Note        | A                    |

| Wired network and signal/ control port |             |                |             |                      |
|--|-------------|----------------|-------------|----------------------|
| Voltage (kV)                           | Test Point  | Polarity (+/-) | Observation | Performance Criteria |
| 0.5                                    | LAN 1       | +/-            | Note        | A                    |
| 0.5                                    | LAN 2       | +/-            | Note        | A                    |
| 0.5                                    | LAN 6 (PoE) | +/-            | Note        | A                    |

Note: The EUT is operated normal during the test.

## 7.10 Surges

### Mode A

#### For EN 55035

|             |                |                          |                             |
|-------------|----------------|--------------------------|-----------------------------|
| Input Power | AC 230V / 50Hz | Environmental conditions | 21 °C, 69 % RH<br>1005 mbar |
| Tested by   | Joey Liu       |                          |                             |

| Input AC power port |            |            |                |             |                      |
|---------------------|------------|------------|----------------|-------------|----------------------|
| Voltage (kV)        | Test Point | Azimuth(°) | Polarity (+/-) | Observation | Performance Criteria |
| 0.5,1               | L-N        | 90, 270    | +/-            | Note        | A                    |
| 0.5,1,2             | L-PE       | 90, 270    | +/-            | Note        | A                    |
| 0.5,1,2             | N-PE       | 90, 270    | +/-            | Note        | A                    |

Note: The EUT is operated normal during the test.

## 7.11 Radio Frequency Common Mode (CS)

### Mode A

#### For EN 55035

|             |                |                          |                             |
|-------------|----------------|--------------------------|-----------------------------|
| Input Power | AC 230V / 50Hz | Environmental conditions | 21 °C, 71 % RH<br>1005 mbar |
| Tested by   | Joey Liu       |                          |                             |

| Input AC power port |               |               |             |                  |             |             |                      |
|---------------------|---------------|---------------|-------------|------------------|-------------|-------------|----------------------|
| Frequency (MHz)     | Level (V rms) | Modulation    | Tested Line | Injection Method | Return Path | Observation | Performance Criteria |
| 0.15 – 10           | 3             | 80% AM (1kHz) | AC power    | CDN-M3           | CDN-M1      | Note 1      | A                    |
| 10 – 30             | 3~1           | 80% AM (1kHz) | AC power    | CDN-M3           | CDN-M1      | Note 1      | A                    |
| 30 – 80             | 1             | 80% AM (1kHz) | AC power    | CDN-M3           | CDN-M1      | Note 1      | A                    |
| 0.15 – 10           | 3             | 80% AM (1kHz) | AC power    | CDN-M3           | CDN-M1      | Note 2      | A                    |
| 10 – 30             | 3~1           | 80% AM (1kHz) | AC power    | CDN-M3           | CDN-M1      | Note 2      | A                    |
| 30 – 80             | 1             | 80% AM (1kHz) | AC power    | CDN-M3           | CDN-M1      | Note 2      | A                    |

| Wired network and signal/ control port |               |               |             |                  |             |             |                      |
|--|---------------|---------------|-------------|------------------|-------------|-------------|----------------------|
| Frequency (MHz)                        | Level (V rms) | Modulation    | Tested Line | Injection Method | Return Path | Observation | Performance Criteria |
| 0.15 – 10                              | 3             | 80% AM (1kHz) | LAN 6 (PoE) | CDN-ST08A        | CDN-M1      | Note 1      | A                    |
| 10 – 30                                | 3~1           | 80% AM (1kHz) | LAN 6 (PoE) | CDN-ST08A        | CDN-M1      | Note 1      | A                    |
| 30 – 80                                | 1             | 80% AM (1kHz) | LAN 6 (PoE) | CDN-ST08A        | CDN-M1      | Note 1      | A                    |
| 0.15 – 10                              | 3             | 80% AM (1kHz) | LAN 1       | CDN-ST08A        | CDN-M1      | Note 1      | A                    |
| 10 – 30                                | 3~1           | 80% AM (1kHz) | LAN 1       | CDN-ST08A        | CDN-M1      | Note 1      | A                    |
| 30 – 80                                | 1             | 80% AM (1kHz) | LAN 1       | CDN-ST08A        | CDN-M1      | Note 1      | A                    |
| 0.15 – 10                              | 3             | 80% AM (1kHz) | LAN 2       | CDN-ST08A        | CDN-M1      | Note 1      | A                    |
| 10 – 30                                | 3~1           | 80% AM (1kHz) | LAN 2       | CDN-ST08A        | CDN-M1      | Note 1      | A                    |
| 30 – 80                                | 1             | 80% AM (1kHz) | LAN 2       | CDN-ST08A        | CDN-M1      | Note 1      | A                    |
| 0.15 – 10                              | 3             | 80% AM (1kHz) | LAN 6 (PoE) | CDN-ST08A        | CDN-M1      | Note 2      | A                    |
| 10 – 30                                | 3~1           | 80% AM (1kHz) | LAN 6 (PoE) | CDN-ST08A        | CDN-M1      | Note 2      | A                    |
| 30 – 80                                | 1             | 80% AM (1kHz) | LAN 6 (PoE) | CDN-ST08A        | CDN-M1      | Note 2      | A                    |
| 0.15 – 10                              | 3             | 80% AM (1kHz) | LAN 1       | CDN-ST08A        | CDN-M1      | Note 2      | A                    |
| 10 – 30                                | 3~1           | 80% AM (1kHz) | LAN 1       | CDN-ST08A        | CDN-M1      | Note 2      | A                    |
| 30 – 80                                | 1             | 80% AM (1kHz) | LAN 1       | CDN-ST08A        | CDN-M1      | Note 2      | A                    |
| 0.15 – 10                              | 3             | 80% AM (1kHz) | LAN 2       | CDN-ST08A        | CDN-M1      | Note 2      | A                    |
| 10 – 30                                | 3~1           | 80% AM (1kHz) | LAN 2       | CDN-ST08A        | CDN-M1      | Note 2      | A                    |
| 30 – 80                                | 1             | 80% AM (1kHz) | LAN 2       | CDN-ST08A        | CDN-M1      | Note 2      | A                    |

#### Notes:

1. The EUT is operated normal during the test.
2. Audio Out Function (Headset out) Electrical Reference level Pass.

## 7.12 Power Frequency Magnetic Field (PFMF)

### Mode A

#### For EN 55035

|             |                |                          |                             |
|-------------|----------------|--------------------------|-----------------------------|
| Input Power | AC 230V / 50Hz | Environmental conditions | 25 °C, 72 % RH<br>1005 mbar |
| Tested by   | Chiming Li     |                          |                             |

| Application | Frequency (Hz) | Field Strength (A/m) | Observation | Performance Criteria |
|-------------|----------------|----------------------|-------------|----------------------|
| X - Axis    | 50             | 1                    | Note        | A                    |
| Y - Axis    | 50             | 1                    | Note        | A                    |
| Z - Axis    | 50             | 1                    | Note        | A                    |

Note: The EUT is operated normal during the test.

## 7.13 Voltage Dips and Interruptions (DIP)

### Mode A

#### For EN 55035

|                     |                |                          |                             |
|---------------------|----------------|--------------------------|-----------------------------|
| Nominal Input Power | AC 230V / 50Hz | Environmental conditions | 24 °C, 72 % RH<br>1006 mbar |
| Tested by           | Joey Liu       |                          |                             |

| Input Power for testing: <u>230Vac, 50 Hz</u> (Nominal input Voltage) |                  |                |       |             |                      |
|---|------------------|----------------|-------|-------------|----------------------|
| Voltage Residual(%)   | Duration (cycle) | Interval (sec) | Times | Observation | Performance Criteria |
| <5  | 0.5              | 10             | 3     | Note 1      | A                    |
| 70  | 25               | 10             | 3     | Note 1      | A                    |
| <5  | 250              | 10             | 3     | Note 2      | C                    |

| Input Power for testing: <u>240Vac, 50 Hz</u> (Maximum rated input voltage) |                  |                |       |             |                      |
|---|------------------|----------------|-------|-------------|----------------------|
| Voltage Residual(%)   | Duration (cycle) | Interval (sec) | Times | Observation | Performance Criteria |
| <5  | 0.5              | 10             | 3     | Note 1      | A                    |
| 70  | 25               | 10             | 3     | Note 1      | A                    |
| <5  | 250              | 10             | 3     | Note 2      | C                    |

| Input Power for testing: <u>100Vac, 50 Hz</u> (Minimum rated input voltage) |                  |                |       |             |                      |
|---|------------------|----------------|-------|-------------|----------------------|
| Voltage Residual(%)   | Duration (cycle) | Interval (sec) | Times | Observation | Performance Criteria |
| <5  | 0.5              | 10             | 3     | Note 1      | A                    |
| 70  | 25               | 10             | 3     | Note 2      | C                    |
| <5  | 250              | 10             | 3     | Note 2      | C                    |

Notes:

1. The EUT is operated normal during the test.
2. The EUT reset during the test, after the test, the equipment needs operator to reset.

## 8 Pictures of Test Arrangements

### 8.1 Conducted Emissions from Power Ports

#### Mode A and B

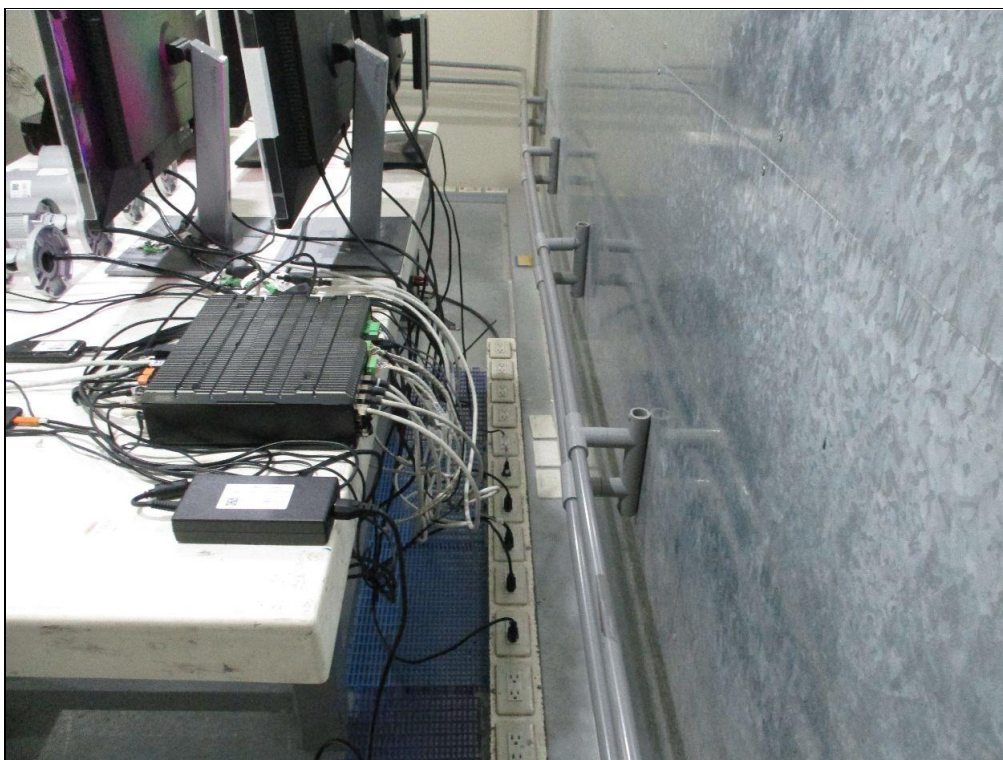
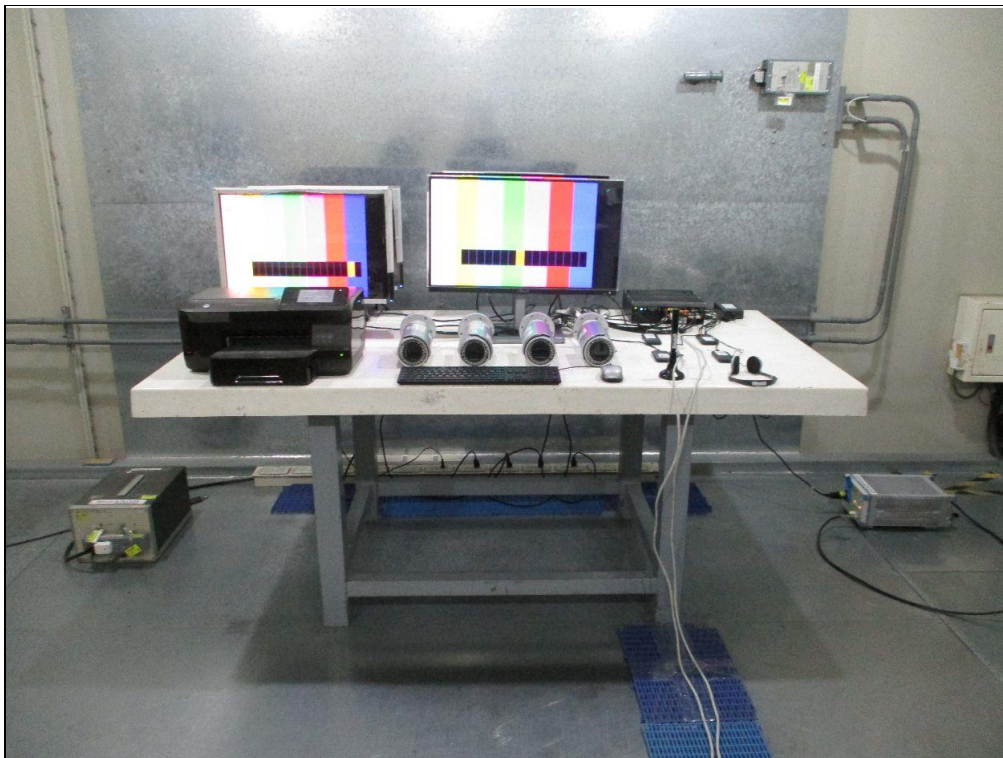

## 8.2 Conducted Emissions from Wired Network Ports

### Mode A

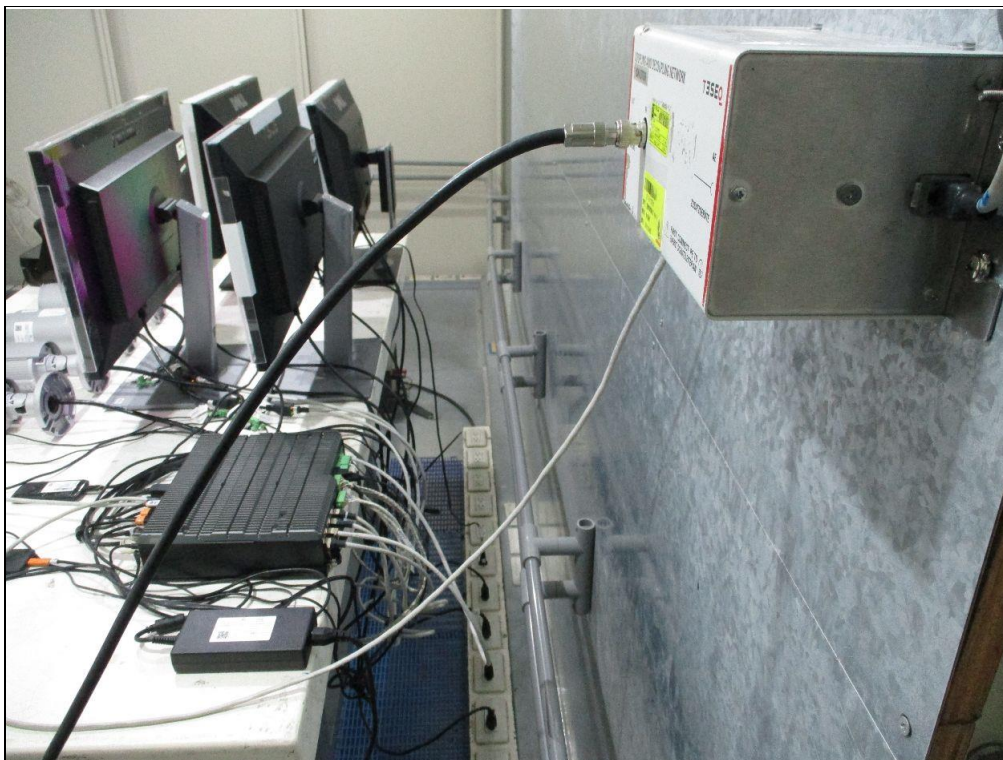

Mode B





Mode C

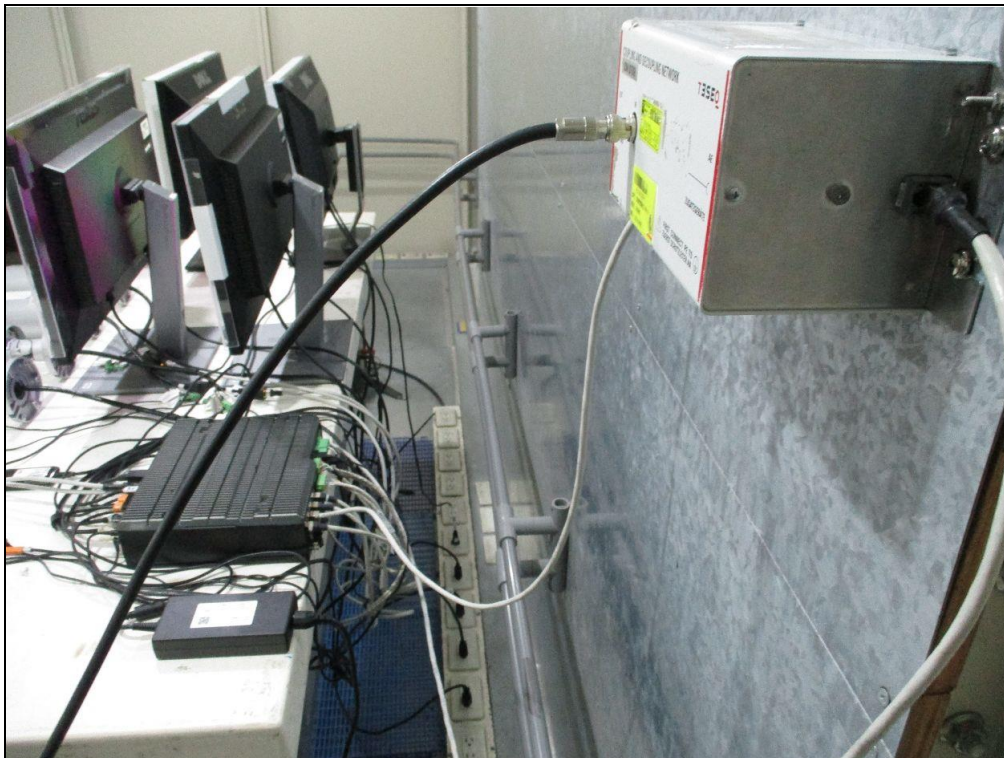

### 8.3 Radiated Emissions up to 1 GHz

#### Mode A

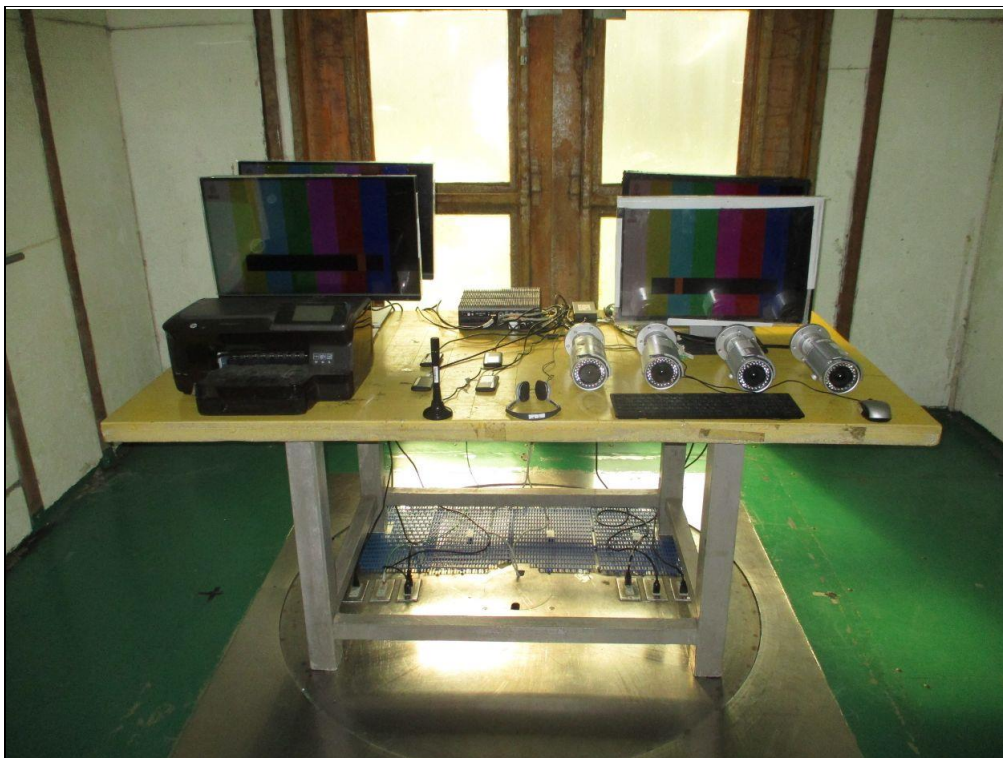

## 8.4 Radiated Emissions above 1 GHz

### Mode A

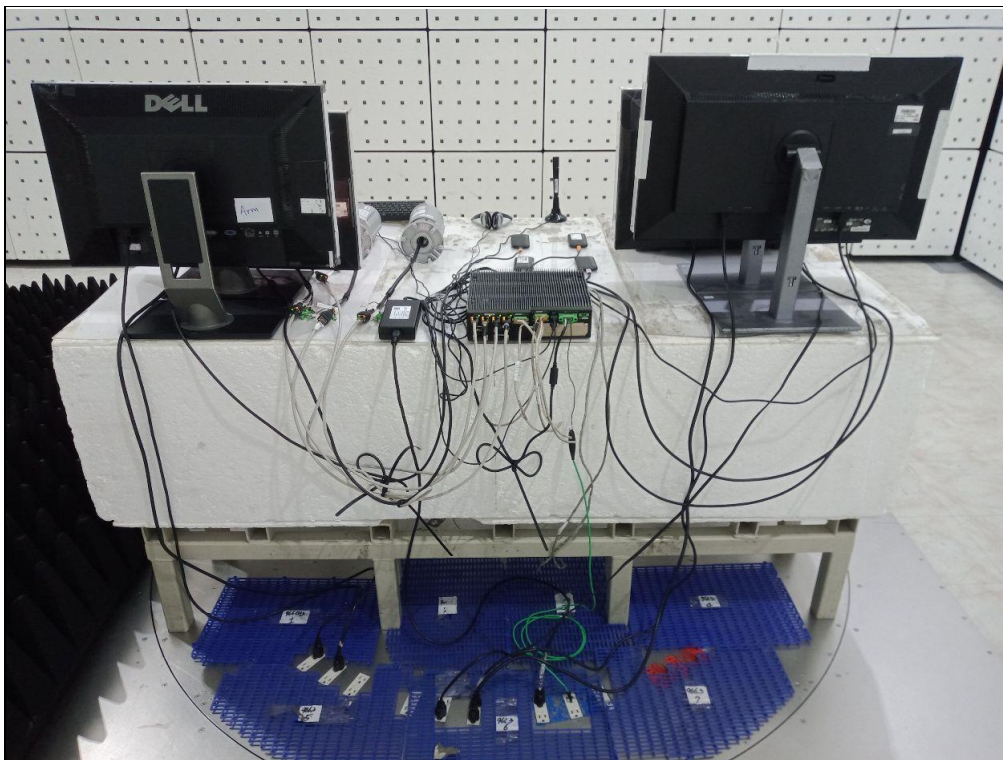

## 8.5 Harmonic Current Measurement

### Mode A

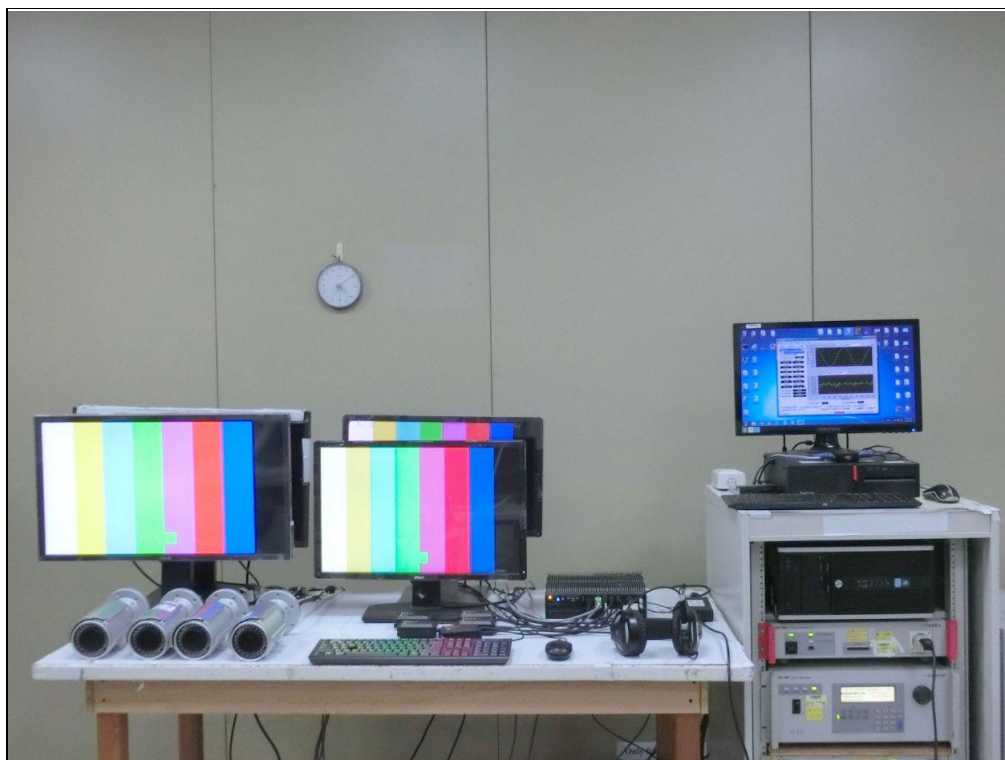

## 8.6 Voltage Fluctuations and Flicker Measurement

### Mode A

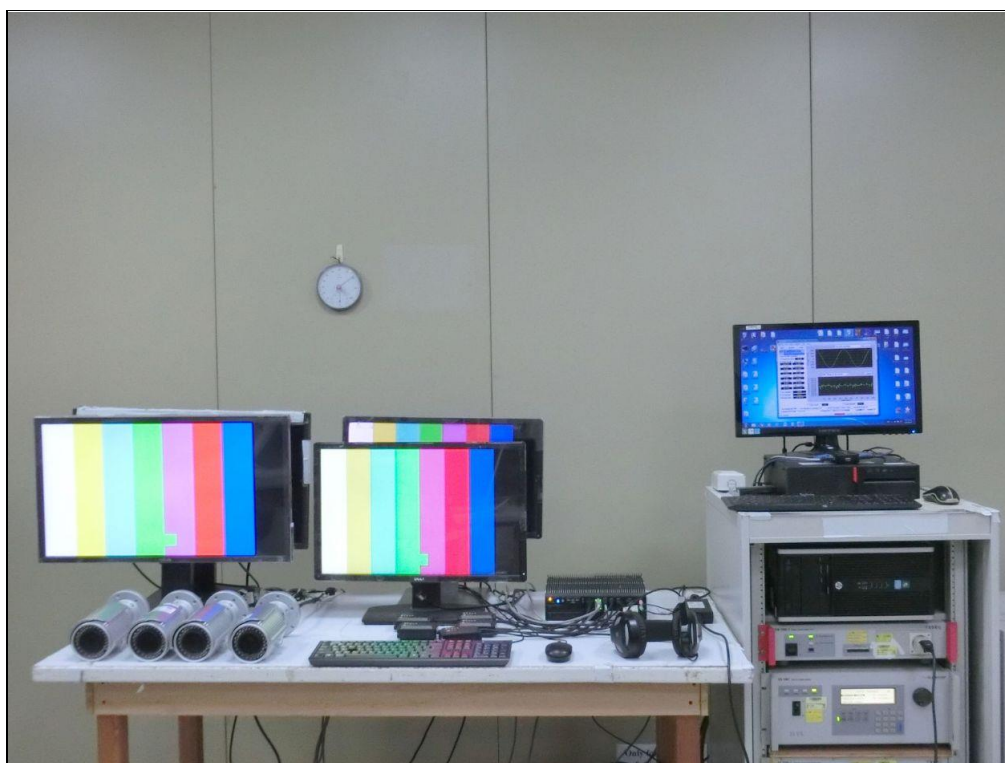

## 8.7 Electrostatic Discharges (ESD)

### Mode A



## 8.8 Radio Frequency Electromagnetic Field (RS)

### Mode A

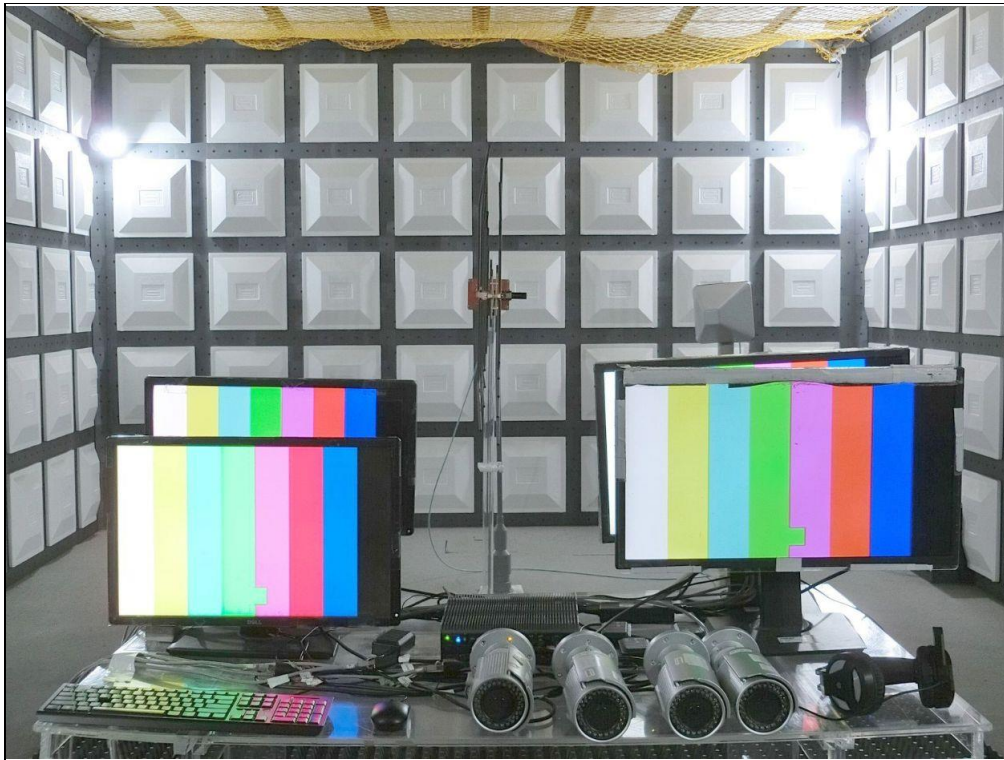

## 8.9 Fast Transients Common Mode (EFT)

### Mode A

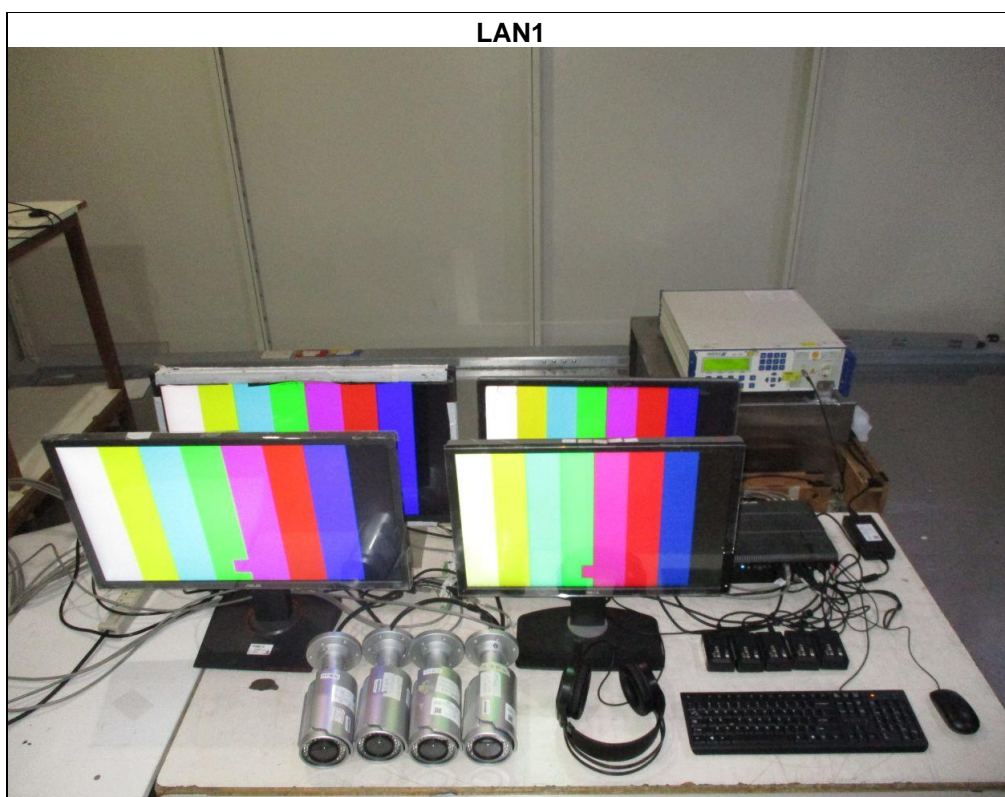

LAN2

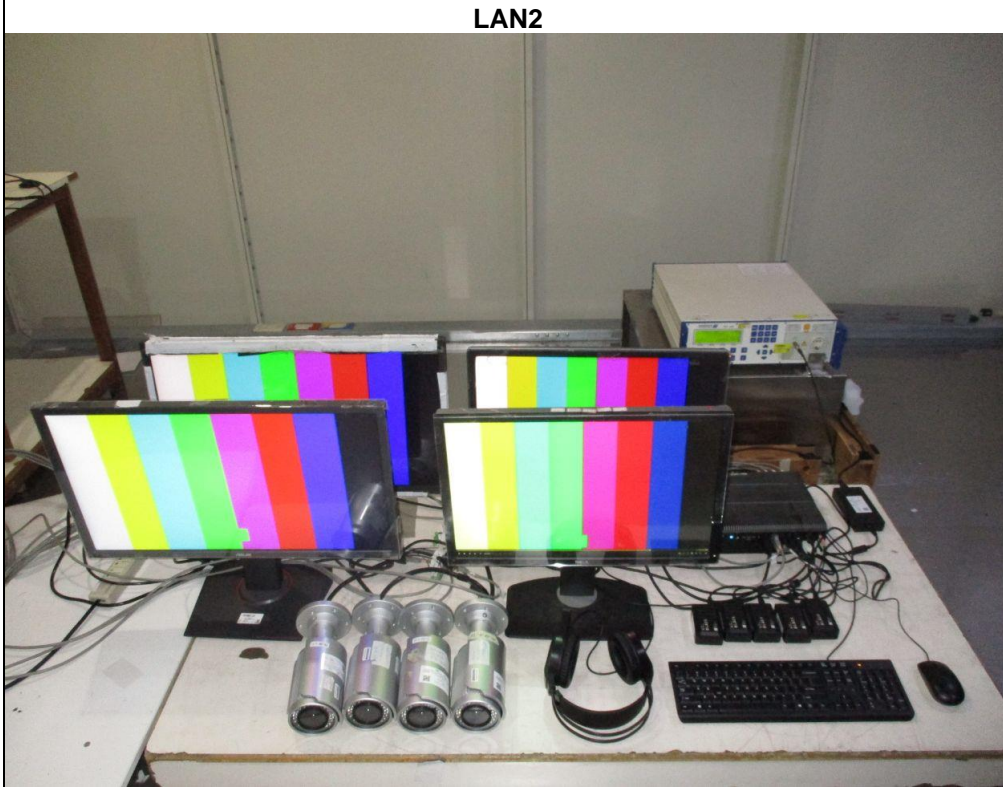

POE LAN





## 8.10 Surges

### Mode A



## 8.11 Radio Frequency Common Mode (CS)

### Mode A

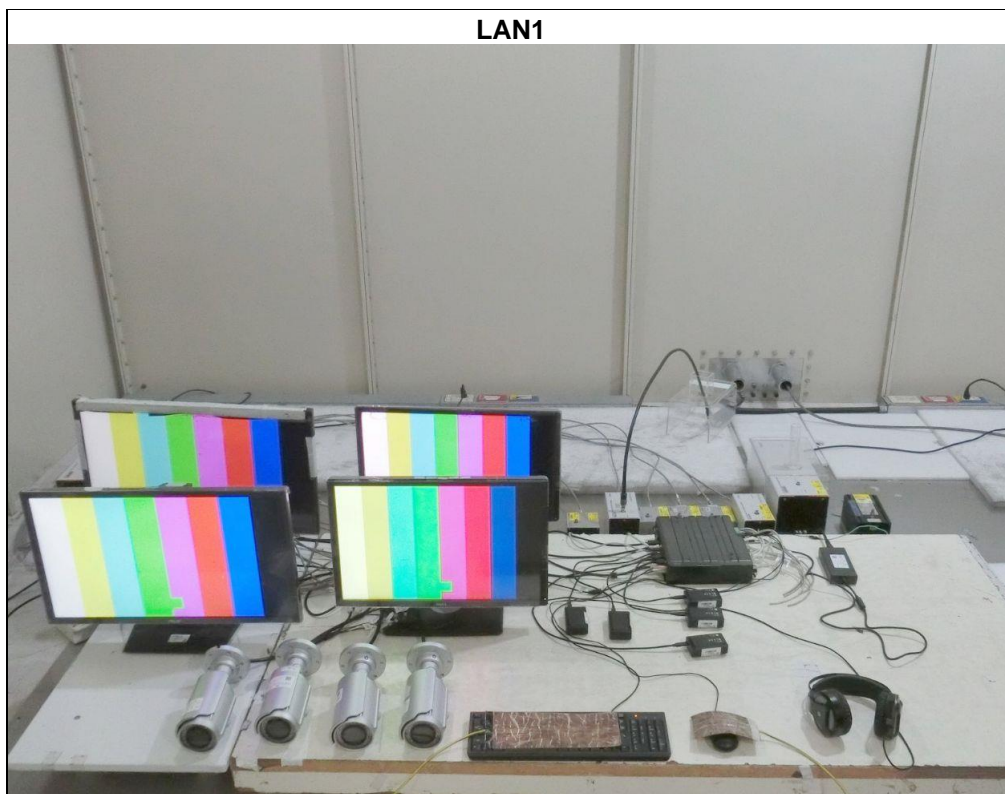
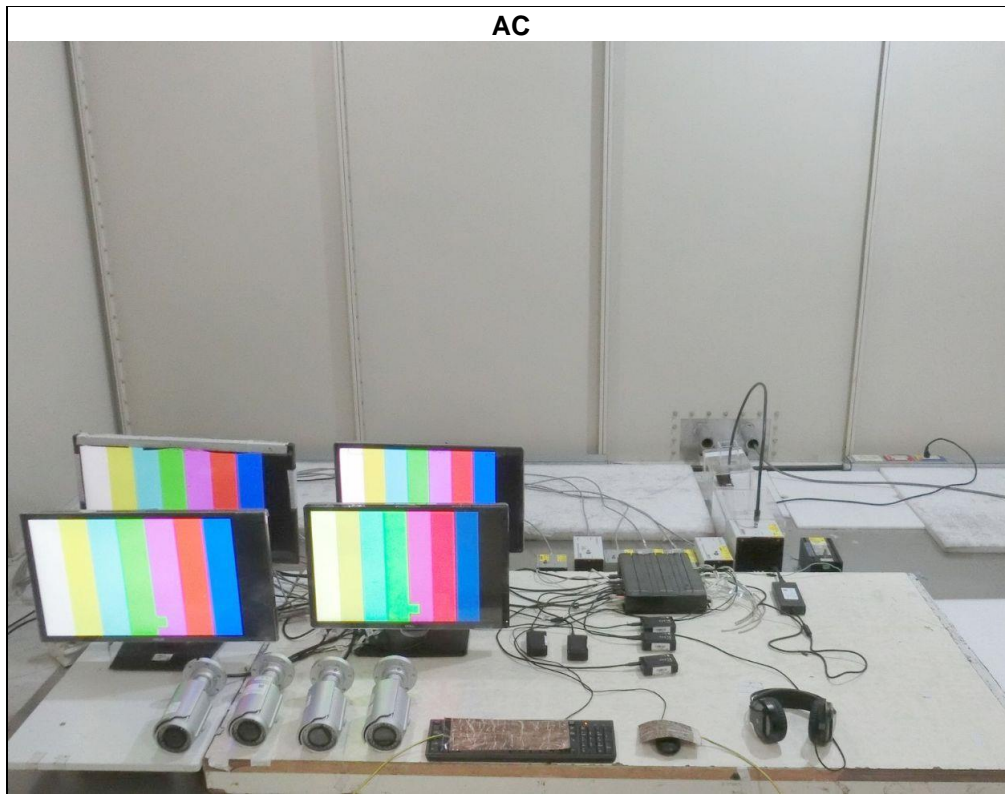

LAN2

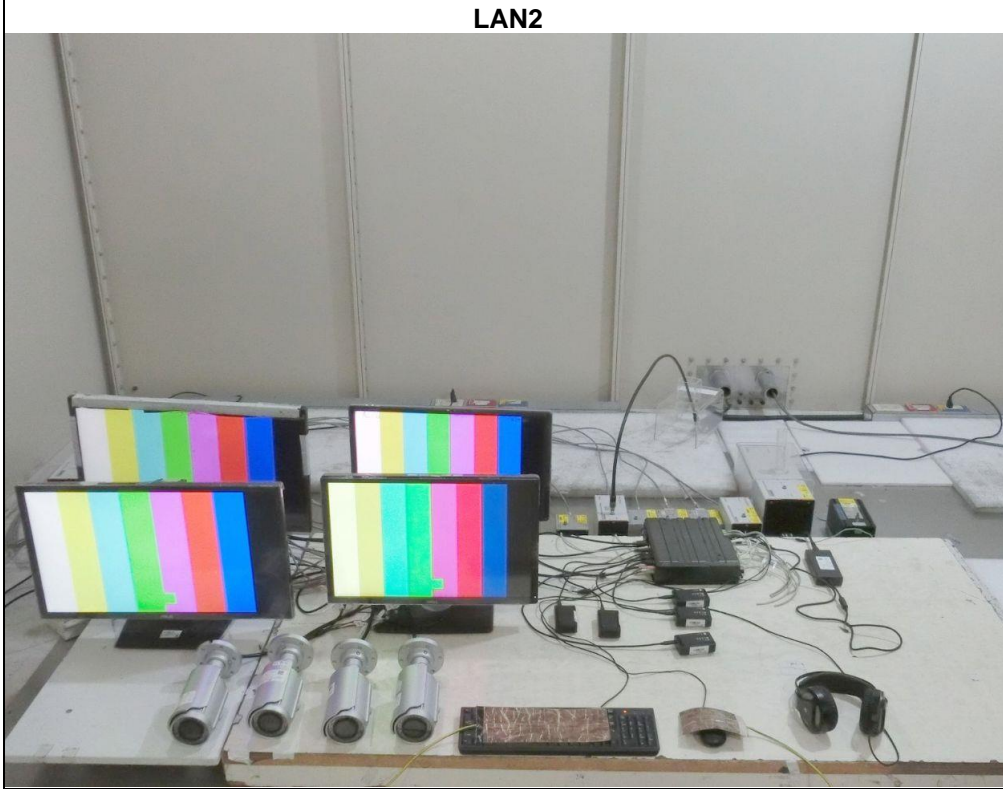

POE LAN

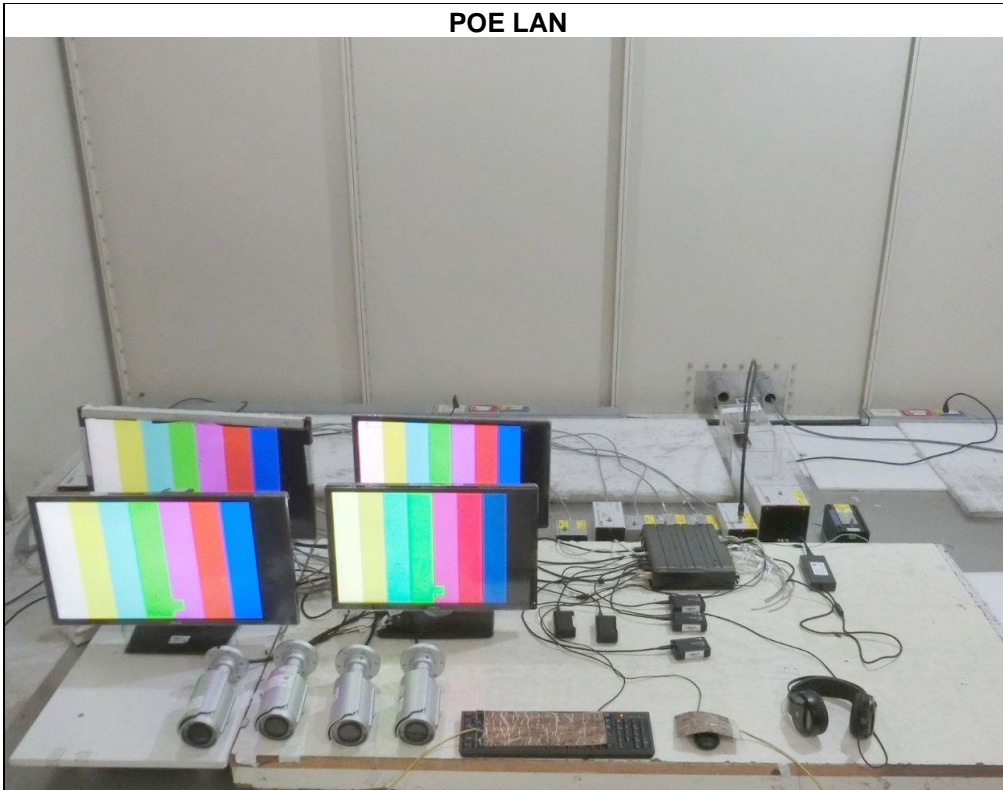

## 8.12 Power Frequency Magnetic Field (PFMF)

### Mode A



## 8.13 Voltage Dips and Interruptions (DIP)

### Mode A



## 9 Information of the Testing Laboratories

We, Bureau Veritas Consumer Products Services (H.K.) Ltd., Taoyuan Branch, were founded in 1988 to provide our best service in EMC, Radio, Telecom and Safety consultation. Our laboratories are FCC recognized accredited test firms and accredited according to ISO/IEC 17025.

If you have any comments, please feel free to contact us at the following:

**Lin Kou EMC/RF Lab**

Tel: 886-2-26052180

Fax: 886-2-26051924

**Hsin Chu EMC/RF/Telecom Lab**

Tel: 886-3-6668565

Fax: 886-3-6668323

**Hwa Ya EMC/RF/Safety Lab**

Tel: 886-3-3183232

Fax: 886-3-3270892

**Email:** [service.adt@bureauveritas.com](mailto:service.adt@bureauveritas.com)

**Web Site:** <http://ee.bureauveritas.com.tw>

The address and road map of all our labs can be found in our web site also.

--- END ---